

COLLECTIONS

HOMEVENTUNO

QUALITÀ E DESIGN DELL'ARREDAMENTO ITALIANO
QUALITY AND DESIGN OF ITALIAN FURNITURE

NON BASTA SCEGLIERE UN BEL MOBILE. Bisogna pensare a come ambientarlo, come fonderlo con l'atmosfera della casa e con lo spirito di chi la vive. Competenza e gusto dell'arredatore si rivelano preziosi nel creare un progetto omogeneo fatto di soluzioni e accostamenti a cui il cliente, forse, non avrebbe mai pensato. Ti stiamo proponendo un intervento progettuale che spazia sull'intero aspetto estetico e funzionale: dal colore delle pareti alla scelta dei complementi, allo studio dell'illuminazione. Il risultato è una casa personale da vivere con piacere.

NOT JUST CHOOSING A NICE FURNITURE. You have to think about how to set it up, how to blend it with the atmosphere of the home and with the spirit of those who live it. Competence and taste of the builder are valuable in creating a homogeneous project made of solutions and approaches that the customer might not have thought of. We are proposing a design project that spans the entire aesthetic and functional aspect: from the color of the walls to the choice of the complement, to the study lighting. The result is a personal home to be enjoyed with pleasure.

COLLECTIONS HOMEVENTUNO



COLLECTIONS HOMEVENTUNO

NON BASTA SCEGLIERE UN BEL MOBILE. Bisogna pensare a come ambientarlo, come fonderlo con l'atmosfera della casa e con lo spirito di chi la vive. Competenza e gusto dell'arredatore si rivelano preziosi nel creare un progetto omogeneo fatto di soluzioni e accostamenti a cui il cliente, forse, non avrebbe mai pensato. Ti stiamo proponendo un intervento progettuale che spazia sull'intero aspetto estetico e funzionale: dal colore delle pareti alla scelta dei complementi, allo studio dell'illuminazione. Il risultato è una casa personale da vivere con piacere.

NOT JUST CHOOSING A NICE FURNITURE. You have to think about how to set it up, how to blend it with the atmosphere of the home and with the spirit of those who live it. Competence and taste of the builder are valuable in creating a homogeneous project made of solutions and approaches that the customer might not have thought of. We are proposing a design project that spans the entire aesthetic and functional aspect: from the color of the walls to the choice of the complement, to the study lighting. The result is a personal home to be enjoyed with pleasure.



COLLECTIONS MYLOFT



COLLECTIONS MYLOFT

UN'ABITAZIONE RICAVATA DA UN AMBIENTE UNICO
A HOUSE MADE FROM A UNIQUE ENVIRONMENT



UN'ABITAZIONE RICAVATA DA UN AMBIENTE UNICO, di solito uno spazio industriale o commerciale dismesso di notevole superficie, caratterizzato da quasi totale assenza di divisori e da altezze interne maggiori rispetto agli immobili costruiti ad uso residenziale e maggiori superfici finestrate, con inserimento di dotazioni igienico-sanitarie adatte all'uso di abitazioni particolarmente confortevoli e personalizzate. Si dice loft anche un'abitazione molto ampia che segue lo stesso stile nell'utilizzo e nell'organizzazione aperta degli spazi interni. Lo studio della trasformazione è particolarmente riuscito se eseguito partendo dalla valorizzazione degli elementi preesistenti resi funzionali con il nuovo utilizzo residenziale. Il recupero di spazi industriali dismessi ad uso abitativo presenta anche l'aspetto positivo di evitare il consumo di territorio con nuove costruzioni, sottraendo i manufatti ad una condizione di progressivo degrado con evidente recupero del paesaggio. La parola inglese loft, il cui significato proprio è solaio/soffitto, deriva dal norvegese antico "lopt" ("aria", confrontabile con il tedesco "luft", con il medesimo significato). Le prime esperienze di realizzazione di loft risalgono agli anni '70 del Novecento e traggono origine dall'allestimento di case-atelier da parte di artisti americani nei pressi di New York.

A HOUSE OBTAINED FROM A UNIQUE ENVIRONMENT, usually an abandoned industrial or commercial space of considerable surface, characterized by the almost total absence of partitions and by greater internal heights compared to buildings built for residential use and greater windowed surfaces, with the inclusion of hygienic equipment - sanitary suitable for the use of particularly comfortable and personalized homes. A very large house is also called a loft that follows the same style in the use and open organization of the interior spaces. The transformation study is particularly successful if carried out starting from the enhancement of the pre-existing elements made functional with the new residential use. The recovery of disused industrial spaces for residential use also has the positive aspect of avoiding the consumption of land with new buildings, subtracting the buildings from a condition of progressive degradation with evident recovery of the landscape. The English word loft, whose proper meaning is attic / ceiling, comes from the Old Norse "lopt" ("air", comparable with the German "luft", with the same meaning). The first experiences in the creation of lofts date back to the 1970s and originate from the setting up of house-ateliers by American artists near New York.

ARREDARE CON LA PROFESSIONALITÀ DEL DESIGN MODERNO CHE SI INTEGRA FRA FUNZIONALITÀ E GUSTO ESTETICO. Elementi d'arredo protagonisti di casa che vi aiutano a trascorrere ogni momento della vostra vita quotidiana da passare in famiglia o con un'allegria compagnia di amici. Articoli per ogni uso come la sala pranzo arredata da una vasta gamma di tavoli con struttura in cristallo, cristallo e legno, totalmente in legno o soluzioni abbinata a gambe in metallo, tutti accompagnati da una numerosa proposta di sedie di ogni tipologia da quella totalmente in legno fino a quelle imbottite. La zona soggiorno è il locale più vissuto della casa impreziosito da vetrine con o senza cassetti abbinata a credenze con ante battenti, ante e cassetti, ante scorrevoli e porta TV il tutto realizzato in diverse finiture e materiali per tutti i gusti in modo da personalizzare la vostra casa. Completano l'ampia collezione le librerie a muro o da centro stanza per suddividere un ampio locale o da protagonista in un loft e consolle abbinata ad attaccapanni e specchiere di estrema semplicità ma con una straordinaria personalità. Comodissimi i tavolini d'appoggio da collocare di fronte ai divani o a fianco a seconda delle esigenze.

FURNISH WITH THE PROFESSIONALISM OF MODERN DESIGN THAT INTEGRATES BETWEEN FUNCTIONALITY AND AESTHETIC TASTE. Furnishing elements protagonists of the home that help you to spend every moment of your daily life to spend with your family or with a cheerful company of friends. Items for every use such as the dining room furnished with a wide range of tables with crystal, crystal and wood structure, totally in wood or solutions combined with metal legs, all accompanied by a numerous proposal of chairs of all types from that totally in wood up to the padded ones. The living area is the most lived-in room in the house embellished with showcases with or without drawers combined with sideboards with hinged doors, doors and drawers, sliding doors and TV stands, all made in different finishes and materials for all tastes in order to personalize your home. The large collection is completed by wall-mounted or freestanding bookcases to divide a large room or as a protagonist in a loft and console combined with extremely simple cabinets and mirrors but with an extraordinary personality. The side tables are very comfortable to be placed in front of the sofas or next to them depending on your needs.



tavolo da l. 160



tavolo da l. 180

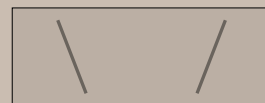

tavolo da l. 200

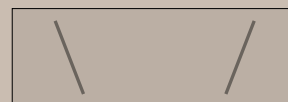

tavolo da l. 220

articolo LF140

tavolo in cristallo, piano rovere
con bordo dritto. crystal table, oak wood
top with straight edge.

misure disponibili: available sizes:

cm. l. 160 h. 78 p. 90

cm. l. 180 h. 78 p. 90

cm. l. 200 h. 78 p. 90

cm. l. 220 h. 78 p. 90

COLLECTION
MYLOFT

articolo LF306

credenza strutturata in MDF ante scorrevoli
in ROVERE, ripiani interni e zoccolo chiuso.
2 sliding doors in OAK sideboard MDF structure,
internal shelves and closed socket.

cm. l. 185,5 p. 50 h. 78

articolo LF246

sedia con fondino imbottito
impilabile in faggio. beech wood chair
with upholstered seat stackable.

cm. l. 45 h. 83 p. 48 h.s. 46





articolo **LF246**
 sedia con fondino imbottito
 impilabile in faggio. beech wood chair
 with upholstered seat stackable.
 cm. l. 45 p. 48 h. 83 h.s. 46



tavolo da cm. 160

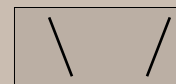

tavolo da cm. 180

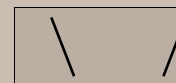

tavolo da cm. 200



tavolo da cm. 220

articolo **LF141**
 tavolo in cristallo, piano rovere
 con bordo naturale. crystal table, oak
 wood top with natural edge.

misure disponibili: available sizes:

cm. l. 160 p. 90 h. 78

cm. l. 180 p. 90 h. 78

cm. l. 200 p. 90 h. 78

cm. l. 220 p. 90 h. 78

COLLECTION
MYLOFT

articolo **LF140**
 tavolo in cristallo, piano rovere
 con bordo dritto. crystal table, oak
 wood top with straight edge.

misure disponibili: available sizes:

cm. l. 160 p. 90 h. 78

cm. l. 180 p. 90 h. 78

cm. l. 200 p. 90 h. 78

cm. l. 220 p. 90 h. 78



articolo **LF130**
 struttura cristallo, piano rovere
 bordo dritto. crystal structure, oak
 wood straight border.

misure disponibili: available sizes:

cm. l. 160 p. 90 h. 78

cm. l. 180 p. 90 h. 78

cm. l. 200 p. 90 h. 78

cm. l. 220 p. 90 h. 78

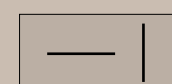

tavolo da cm. 160

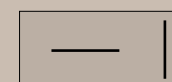

tavolo da cm. 180

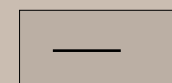

tavolo da cm. 200

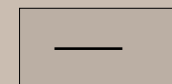

tavolo da cm. 220

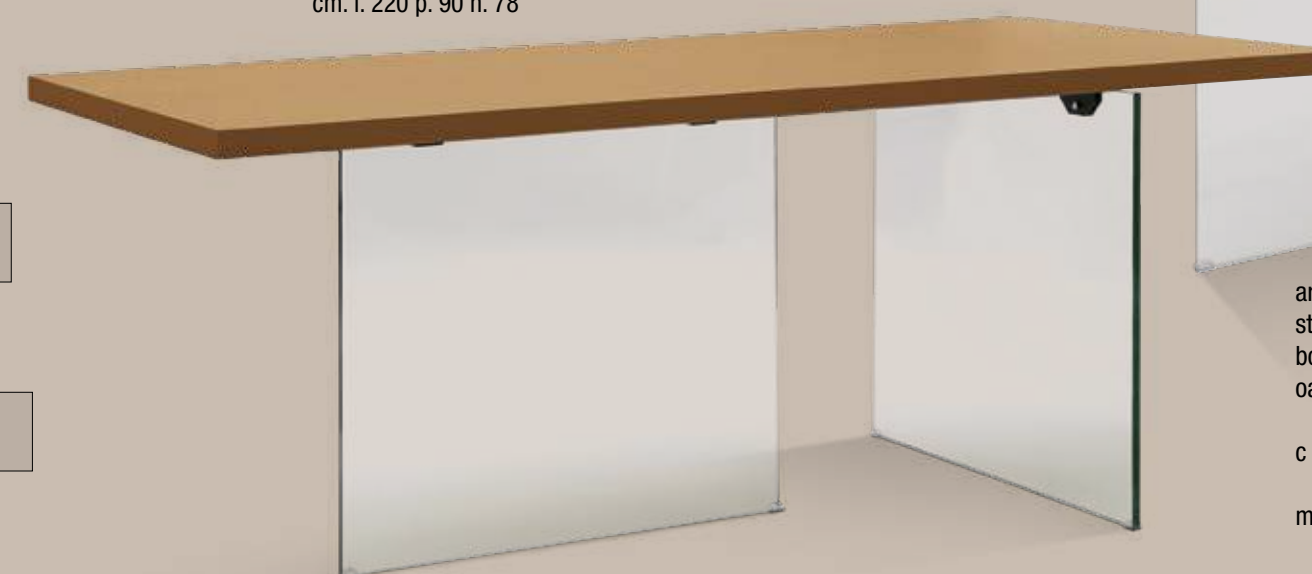

articolo **LF131**
 struttura cristallo, piano rovere
 bordo naturale. crystal structure,
 oak wood top natural border.

c misure disponibili: available sizes:

m. l. 160 p. 90 h. 78

cm. l. 180 p. 90 h. 78

cm. l. 200 p. 90 h. 78

cm. l. 220 p. 90 h. 78



COLLECTION
MYLOFT

articolo LF011
struttura rovere, piano cristallo temperato.
oak wood structure, tempered crystal top.

cm. l. 160 p. 90 h. 77

cm. l. 180 p. 90 h. 77

cm. l. 200 p. 90 h. 77

cm. l. 220 p. 90 h. 77

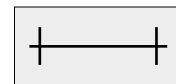

tavolo da cm. 160

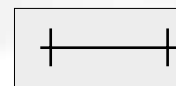

tavolo da cm. 180

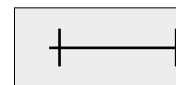

tavolo da cm. 200

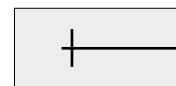

tavolo da cm. 220



articolo 327G
sedia in faggio fondino legno.
beech wood chair wooden seat.
cm. l. 43 p. 46 h. 81,5 h.s. 46,5



articolo LF200
sedia in frassino con fondino imbottito.
ash wood chair with upholstered seat.
cm. l. 68 p. 48 h. 78 h.s. 46



MYLOFT COLLECTION



articolo LF300
credenza in rovere 2 ante, ripiani interni
e piano in vetro. oak wood sideboard 2 doors,
internal shelves and glass top.
cm. l. 120 p. 50 h. 100

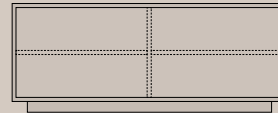

articolo **LF325**
 credenza struttura in rovere 4 porte, ripiani interni e zoccolo chiuso. 4 doors oak structure sideboard internal shelves and closed socket.
 cm. l. 185,5 p. 50 h. 75

articolo **LF340**
 vetrina 1 porta sinistra, zoccolo chiuso. 1 leaf door showcase, closed socket.
 cm. l. 55 p. 45 h. 189

articolo **LF341**
 vetrina 1 porta destra, zoccolo chiuso. 1 right door showcase, closed socket.
 cm. l. 55 p. 45 h. 189

articolo **LF255**
 sedia imbottita ecopelle bianca con fusto bianco. white eco-leather upholstered chair with white frame.
 cm. l. 46 p. 45 h. 100 h.s. 48



articolo **LF135**
 struttura cristallo, piano rovere bordo dritto. crystal structure, oak wood top straight border.

cm. l. 160 p. 110 h. 78

cm. l. 180 p. 120 h. 78

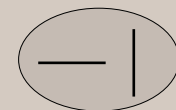

tavolo da cm. 160

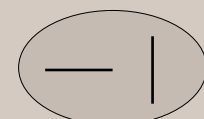

tavolo da cm. 180





articolo LF012
tavolo fisso struttura in rovere piano
in rovere bordo dritto. structure oak wood
fixed table oak top straight border.

misure disponibili: available sizes:

cm. l. 160 p. 90 h. 79

cm. l. 180 p. 90 h. 79

cm. l. 200 p. 90 h. 79

cm. l. 220 p. 90 h. 79



articolo LF013
tavolo fisso struttura in rovere piano
in rovere bordo naturale. structure oak wood
fixed table oak top natural border.

misure disponibili: available sizes:

cm. l. 160 p. 90 h. 79

cm. l. 180 p. 90 h. 79

cm. l. 200 p. 90 h. 79

cm. l. 220 p. 90 h. 79

articolo LF254
sedia imbottita ecopelle marrone
con fusto wengè. brown eco-leather
upholstered chair with wenge frame.
cm. l. 46 p. 45 h. 100 h.s. 48

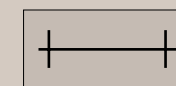

tavolo da cm. 160

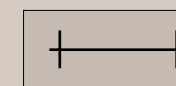

tavolo da cm. 180

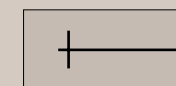

tavolo da cm. 200

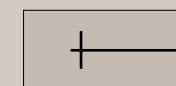

tavolo da cm. 220

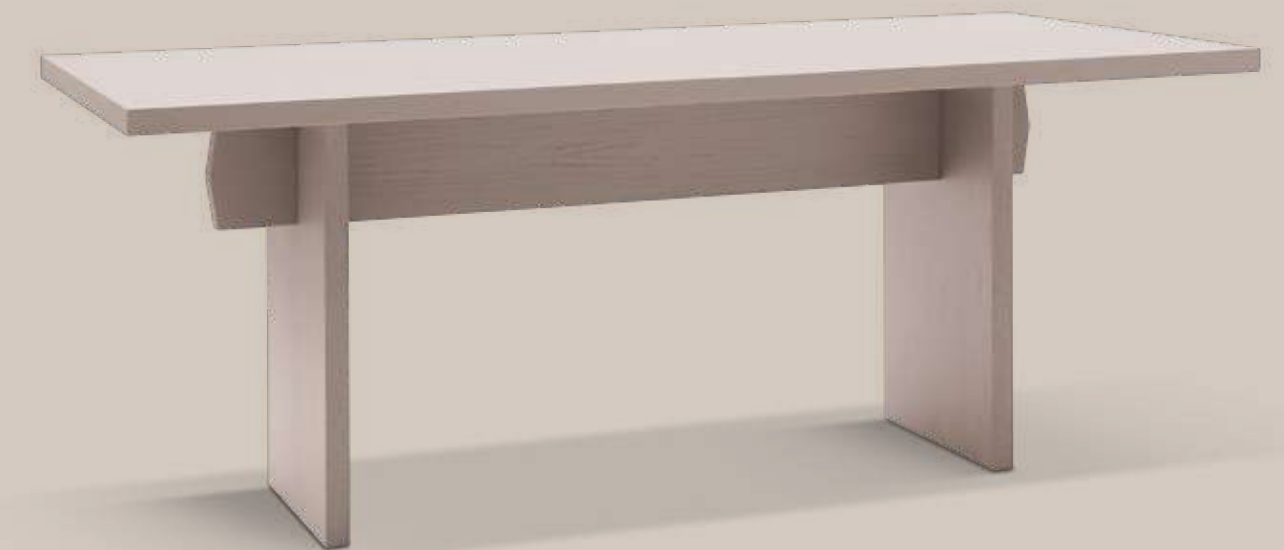

COLLECTION
MYLOFT



articolo LF021
tavolo struttura cristallo e rovere, piano
in cristallo temperato. table crystal and oak
wood structure, tempered glass top.

misure disponibili: available sizes:

cm. l. 160 p. 90 h. 75

cm. l. 180 p. 90 h. 75

cm. l. 200 p. 90 h. 75

cm. l. 220 p. 90 h. 75

articolo LF022
tavolo struttura cristallo e rovere, piano
bordo dritto. rectangular table crystal and
oak wood structure, straight edge top.

misure disponibili: available sizes:

cm. l. 160 p. 90 h. 78

cm. l. 180 p. 90 h. 78

cm. l. 200 p. 90 h. 78

cm. l. 220 p. 90 h. 78



articolo LF231
capotavola in faggio con fondino imbottito.
armchair in beech wood with upholstered seat.
cm. l. 57 p. 50 h. 88 h.s. 48 h.b. 68



articolo LF220
sedia in faggio con fondino imbottito.
chair in beech wood with upholstered seat.
cm. l. 45 p. 50 h. 88 h.s. 48

COLLECTION MYLOFT

articolo LF023
tavolo struttura cristallo e rovere, piano
bordo naturale. rectangular table crystal and
oak wood structure, natural edge top.

misure disponibili: available sizes:

cm. l. 160 p. 90 h. 79

cm. l. 180 p. 90 h. 79

cm. l. 200 p. 90 h. 79

cm. l. 220 p. 90 h. 79

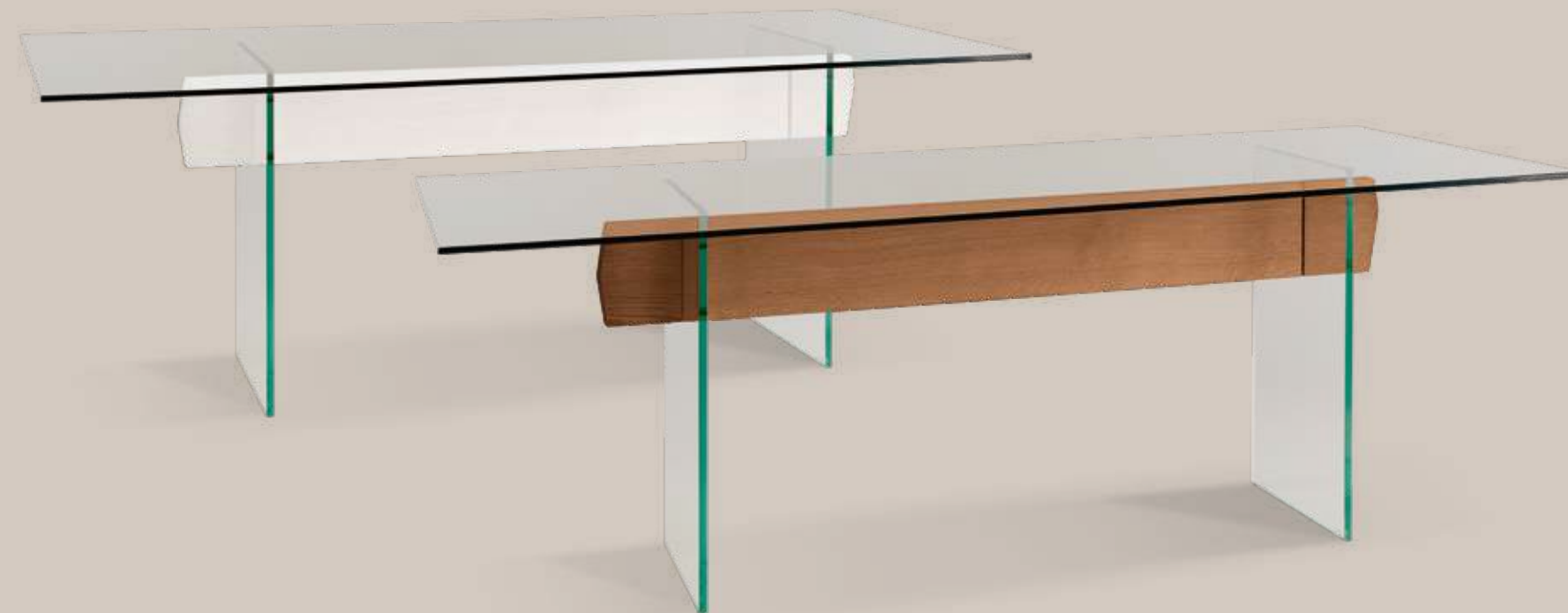

tavolo da cm. 160

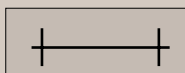

tavolo da cm. 180



tavolo da cm. 200

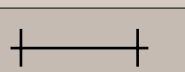

tavolo da cm. 220





articolo **LF345**
 vetrina 1 porta sinistra 2 cassetti,
 zoccolo chiuso. 1 leaf door showcase
 2 drawers, closed socket.
 cm. l. 55 p. 45 h. 189

articolo **LF346**
 vetrina 1 porta destra 2 cassetti,
 zoccolo chiuso. 1 right door showcase
 2 drawers, closed socket.
 cm. l. 55 p. 45 h. 189

articolo **LF347**
 vetrina 1 porta sinistra 2 cassetti
 e gambe spillo. 1 leaf door showcase
 2 drawers and pin legs.
 cm. l. 55 p. 45 h. 199

articolo **LF348**
 vetrina 1 porta destra 2 cassetti
 e gambe spillo. 1 right door showcase
 2 drawers and pin legs.
 cm. l. 55 p. 45 h. 199

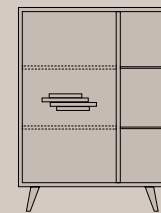

articolo **LF331**
 vetrina 2 porte, gambe spillo
 e ripiani interni. 2 doors showcase,
 pin legs and internal shelves.
 cm. l. 100 p. 50 h. 144

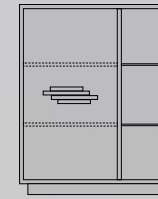

articolo **LF330**
 vetrina 2 porte, zoccolo chiuso
 e ripiani interni. 2 doors showcase,
 closed socket and internal shelves.
 cm. l. 100 p. 50 h. 134

articolo **LF021**
 tavolo rettangolare struttura cristallo
 e rovere, piano in cristallo temperato.
 rectangular table crystal and oak wood
 structure, tempered glass top.
 chair in ash wood with wooden seat.



COLLECTION
MYLOFT



articolo **LF050**
tavolo in ROVERE allungabile (con 5 allunghe da cm. 50 x 90). extensible table in OAK WOOD (with 5 extensions cm. 50 x 90).

articolo **LF235**
sedia in faggio con fondino imbottito. beech wood chair with upholstered seat. cm. l. 41 p. 46,5 h. 87 hs. 45,5

articolo **LF236**
sgabello in faggio con fondino imbottito. stool in beech wood with upholstered seat. cm. l. 41,5 p. 47 h. 109 h.s. 80



COLLECTION
MYLOFT



articolo **LF050**
tavolo in ROVERE allungabile (con 5 allunghe da cm. 50 x 90). extensible table in OAK WOOD (with 5 extensions cm. 50 x 90).



cm. l. 90 p. 90 h. 76



cm. l. 140 p. 90 h. 76

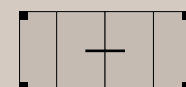

cm. l. 190 p. 90 h. 76



cm. l. 240 p. 90 h. 76



cm. l. 290 p. 90 h. 76



cm. l. 340 p. 90 h. 76



articolo **LF051**
tavolo in ROVERE allungabile (con 5 allunghe da cm. 50 x 80). extensible table in OAK WOOD (with 5 extensions cm. 50 x 80).

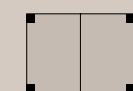

cm. l. 120 p. 80 h. 76



cm. l. 170 p. 80 h. 76

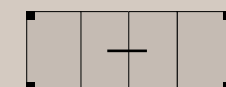

cm. l. 220 p. 80 h. 76



cm. l. 270 p. 80 h. 76



cm. l. 320 p. 80 h. 76



cm. l. 370 p. 80 h. 76

articolo **LF052**
consolle in ROVERE allungabile (con 5 allunghe da cm. 50 x 90). extensible console in OAK WOOD (with 5 extensions cm. 50 x 90).



cm. l. 50 p. 90 h. 76

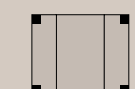

cm. l. 100 p. 90 h. 76

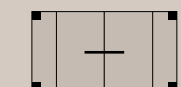

cm. l. 150 p. 90 h. 76



cm. l. 200 p. 90 h. 76



cm. l. 250 p. 90 h. 76



cm. l. 300 p. 90 h. 76



COLLECTION
MYLOFT



articolo LF050
tavolo in ROVERE allungabile (con 5 allunghe da cm. 50 x 90). extensible table in OAK WOOD (with 5 extensions cm. 50 x 90).



5 allunghe da cm. 50.
5 extensions cm. 50.



articolo LF255
sedia imbottita ecopelle bianca con fusto bianco. white eco-leather upholstered chair with white frame. cm. l. 46 p. 45 h. 100 h.s. 48



articolo LF235
sedia in faggio con fondino imbottito. beech wood chair with upholstered seat. cm. l. 41 p. 46,5 h. 87 hs. 45,5



COLLECTION MYLOFT



articolo LF261
sedia imbottita ecopelle marrone
con bottoni fusto wengè. brown eco-leather
upholstered chair with buttons wengè frame.
cm. l. 46 p. 45 h. 100 hs. 48



articolo LF258
sedia imbottita ecopelle beige
con fusto rovere. beige eco-leather
upholstered chair with oak wood frame.
cm. l. 46 p. 45 h. 100 h.s. 48



articolo LF265
sedia imbottita ecopelle beige
con fusto beige. beige eco-leather
upholstered chair with beige frame.
cm. l. 46 p. 45 h. 100 h.s. 48



articolo LF257
sedia imbottita ecopelle bianca
con fusto rovere. white eco-leather
upholstered chair with oak wood frame.
cm. l. 46 p. 45 h. 100 h.s. 48



articolo LF259
sedia imbottita ecopelle grigia
con fusto grigio. gray eco-leather
upholstered chair with gray frame.
cm. l. 46 p. 45 h. 100 h.s. 48



articolo LF254
sedia imbottita ecopelle marrone
con fusto wengè. brown eco-leather
upholstered chair with wengè wood frame.
cm. l. 46 p. 45 h. 100 h.s. 48

articolo LF269
sedia imbottita ecopelle grigia
con fusto grigio. gray eco-leather
upholstered chair with gray frame.
cm. l. 46 p. 53 h. 99 h.s. 48

articolo LF260
sedia imbottita ecopelle beige
con bottoni fusto bianco. beige eco-leather
upholstered chair with buttons white frame.
cm. l. 46 p. 45 h. 100 hs. 48



articolo LF031
tavolo con struttura in rovere, piano
in cristallo temperato. table structure
in oak wood, tempered glass top.

misure disponibili: available sizes:

cm. l. 160 p. 90 h. 77

cm. l. 180 p. 90 h. 77

cm. l. 200 p. 90 h. 77

cm. l. 220 p. 90 h. 77





articolo **LF085**
 basamento in metallo colore nero, piano rovere con bordo naturale. black metal basament, oak wood top with natural edge.

misure disponibili:
 available sizes:

- cm. l. 160 p. 90 h. 79
- cm. l. 180 p. 90 h. 79
- cm. l. 200 p. 90 h. 79
- cm. l. 220 p. 90 h. 79

COLLECTION
MYLOFT



articolo **LF084**
 basamento in metallo colore nero, piano rovere con bordo dritto. black metal basament, oak wood top with straight edge.

misure disponibili: available sizes:

- cm. l. 160 p. 90 h. 79
- cm. l. 180 p. 90 h. 79
- cm. l. 200 p. 90 h. 79
- cm. l. 220 p. 90 h. 79



articolo **LF206Z**
 sedia con gambe metallo
 imbottitura Time. chair with metal
 legs Time upholstered.
 cm. l. 45 p. 54 h. 90 h.s. 49



articolo **LF207Z**
 sedia con gambe metallo
 imbottitura Inghilterra. chair with metal
 legs England upholstered.
 cm. l. 45 p. 54 h. 90 h.s. 49



articolo **LF208Z**
 sedia con gambe metallo
 imbottitura City. chair with metal
 legs City upholstered.
 cm. l. 45 p. 54 h. 90 h.s. 49



articolo **LF209Z**
 sedia con gambe metallo imbottita
 ecopelle panna. chair with metal legs
 upholstered cream eco-leather.
 cm. l. 45 p. 54 h. 90 h.s. 49

articolo LF086
 basamento in metallo colore bianco, piano
 rovere con bordo dritto. white metal basement,
 oak wood top with straight edge.

misure disponibili: available sizes:

cm. l. 160 p. 90 h. 79

cm. l. 180 p. 90 h. 79

cm. l. 200 p. 90 h. 79

cm. l. 220 p. 90 h. 79



articolo LF265
 sedia imbottita ecopelle beige
 con fusto beige. beige eco-leather
 upholstered chair with beige frame.
 cm. l. 46 p. 45 h. 100 h.s. 48

articolo LF032
 tavolo rovere, piano rovere con bordo dritto.
 oak wood table, oak wood top with straight edge.

misure disponibili: available sizes:

cm. l. 160 p. 90 h. 79

cm. l. 180 p. 90 h. 79

cm. l. 200 p. 90 h. 79

cm. l. 220 p. 90 h. 79

articolo LF269
 sedia imbottita ecopelle antracite
 fusto antracite. anthracite eco-leather
 upholstered chair anthracite frame.
 cm. l. 46 p. 45 h. 100 h.s. 48



articolo LF087
 basamento in metallo colore bianco, piano
 rovere con bordo naturale. white metal basement,
 oak wood top with natural edge.

misure disponibili: available sizes:

cm. l. 160 p. 90 h. 79

cm. l. 180 p. 90 h. 79

cm. l. 200 p. 90 h. 79

cm. l. 220 p. 90 h. 79

COLLECTION MYLOFT

articolo LF263
 sedia ecopelle bianca con bottoni fusto bianco.
 white eco-leather chair with buttons white frame.
 cm. l. 46 p. 45 h. 100 h.s. 48



articolo LF033
 tavolo rovere, piano rovere
 con bordo naturale. oak wood table,
 oak wood top with natural border.

misure disponibili: available sizes:

cm. l. 160 p. 90 h. 79

cm. l. 180 p. 90 h. 79

cm. l. 200 p. 90 h. 79

cm. l. 220 p. 90 h. 79

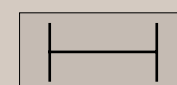

tavolo da l. 160



tavolo da l. 180



tavolo da l. 200



tavolo da l. 220





articolo LF105
 tavolo rettangolare con gambe
 tornite spillo e piano rovere bordo dritto.
 rectangular table with pin turned legs
 and oak wood straight edge top.

misure disponibili: available sizes:

cm. l. 140 p. 90 h. 81

cm. l. 160 p. 90 h. 81

articolo LF106
 tavolo rettangolare con gambe
 tornite spillo e piano rovere bordo naturale.
 rectangular table with pin turned legs
 and oak wood natural edge top.

misure disponibili: available sizes:

cm. l. 140 p. 90 h. 81

cm. l. 160 p. 90 h. 81

articolo LF200
 sedia in frassino con fondino imbottito.
 chair in ash wood with upholstered seat.
 cm. l. 68 p. 48 h. 78 h.s. 46

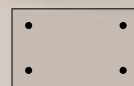

tavolo da cm. l. 140

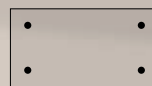

tavolo da cm. l. 160



COLLECTION **MYLOFT**

articolo LF107
 tavolo ovale con gambe
 tornite spillo e piano rovere bordo dritto.
 oval table with pin turned legs
 and oak wood straight edge top.

misure disponibili: available sizes:

cm. l. 160 p. 110 h. 81

cm. l. 180 p. 120 h. 81

articolo LF200
 sedia in frassino con fondino imbottito.
 chair in ash wood with upholstered seat.
 cm. l. 68 p. 48 h. 78 h.s. 46

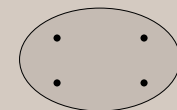

tavolo da cm. l. 160

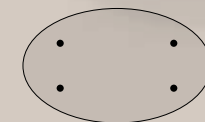

tavolo da cm. l. 180





articolo LF100
tavolo rettangolare con gambe tornite e piano rovere bordo dritto. rectangular table with turned legs and oak wood straight edge top.

misure disponibili: available sizes:

cm. l. 140 p. 90 h. 76

cm. l. 160 p. 90 h. 76

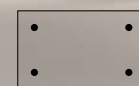

tavolo da cm. l. 140



tavolo da cm. l. 160

articolo LF280
sedia ecopelle invecchiata beige con fusto tortora. beige aged eco-leather chair with dove gray frame.

cm. l. 46 p. 45 h. 100 h.s. 48

piano bordo naturale. natural edge top.

piano bordo dritto. straight edge top.

articolo LF101
tavolo rettangolare con gambe tornite e piano rovere bordo naturale. rectangular table with turned legs and oak wood natural edge top.

misure disponibili: available sizes:

cm. l. 140 p. 90 h. 76

cm. l. 160 p. 90 h. 76



articolo LF282
sedia ecopelle invecchiata grigia con fusto grigio. gray aged eco-leather chair with gray frame.
cm. l. 46 p. 45 h. 100 h.s. 48

articolo LF281
sedia ecopelle invecchiata marrone con fusto marrone. brown aged eco-leather chair with brown frame.
cm. l. 46 p. 45 h. 100 h.s. 48

articolo LF103
tavolo ovale con gambe tornite e piano rovere bordo dritto. oval table with turned legs and oak wood straight edge top.

misure disponibili: available sizes:

cm. l. 160 p. 110 h. 76

cm. l. 180 p. 120 h. 76



tavolo da cm. l. 160



tavolo da cm. l. 180



tavolo da cm. l. 160

articolo LF104
tavolo rotondo con gambe tornite e piano rovere bordo dritto. round table with turned legs and oak wood straight edge top.
cm. ø. 110 h. 76



articolo LF326
 credenza struttura in ROVERE 4 porte, ripiani
 interni e gambe a spillo. 4 doors OAK structure
 sideboard internal shelves and pin legs.
 cm. l. 185,5 p. 50 h. 85



articolo LF342
 vetrina 1 porta sinistra e gambe spillo.
 1 leaf door showcase and pin legs.
 cm. l. 55 p. 45 h. 199

articolo LF343
 vetrina 1 porta destra e gambe spillo.
 1 right door showcase and pin legs.
 cm. l. 55 p. 45 h. 199

articolo LF428
 tavolino rotondo e gambe spillo.
 round coffee table and pin legs.
 cm. l. 60 p. 60 h. 63

COLLECTION
 MYLOFT





COLLECTION
MYLOFT

articolo **LF340**
vetrina 1 porta sinistra, zoccolo chiuso.
1 leaf door showcase, closed socket.
cm. l. 55 p. 45 h. 189

articolo **LF341**
vetrina 1 porta destra, zoccolo chiuso.
1 right door showcase, closed socket.
cm. l. 55 p. 45 h. 189



articolo **LF325**
credenza struttura in ROVERE 4 porte, ripiani
interni e zoccolo chiuso. 4 doors OAK structure
sideboard internal shelves and closed socket.
cm. l. 185,5 p. 50 h. 75



articolo **LF345**
 vetrina 1 porta sinistra 2 cassetti,
 zoccolo chiuso. 1 leaf door showcase
 2 drawers, closed socket.
 cm. l. 55 p. 45 h. 189

articolo **LF346**
 vetrina 1 porta destra 2 cassetti,
 zoccolo chiuso. 1 right door showcase
 2 drawers, closed socket.
 cm. l. 55 p. 45 h. 189

articolo **LF311**
 porta TV struttura in MDF 2 ante
 scorrevoli in ROVERE e zoccolo chiuso.
 TV-stand MDF structure 2 OAK wood
 sliding doors and closed socket.
 cm. l. 185,5 p. 50 h. 44,5

articolo **LF340**
 vetrina 1 porta sinistra, zoccolo chiuso.
 1 leaf door showcase, closed socket.
 cm. l. 55 p. 45 h. 189

articolo **LF341**
 vetrina 1 porta destra, zoccolo chiuso.
 1 right door showcase, closed socket.
 cm. l. 55 p. 45 h. 189



COLLECTION **MYLOFT**



articolo **LF311**
 porta TV struttura in MDF 2 ante
 scorrevoli in ROVERE e zoccolo chiuso.
 TV-stand MDF structure 2 OAK wood
 sliding doors and closed socket.
 cm. l. 185,5 p. 50 h. 44,5

COLLECTION
MYLOFT



soggiorno componibile composto da:
 modular living room composed of:

articolo **LF312**
 porta TV struttura in MDF 2 ante scorrevoli
 in rovere e gambe spillo. TV-stand MDF structure
 2 oak sliding doors and pin legs.
 cm. l. 185,5 p. 50 h. 54,5

articolo **MB152**
 pensile a giorno, compartiment hanging.
 cm. l. 40 p. 17 h. 40

articolo **MB154**
 pensile a giorno, compartiment hanging.
 cm. l. 20 p. 17 h. 80



COLLECTION
MYLOFT

articolo **LF306**
credenza strutturata in MDF ante scorrevoli
in ROVERE, ripiani interni e zoccolo chiuso.
2 sliding doors in OAK sideboard MDF structure,
internal shelves and closed socket.
cm. l. 185,5 p. 50 h. 78



articolo **LF307**
credenza strutturata in MDF ante scorrevoli
in ROVERE, ripiani interni e gambe spillo.
2 sliding doors in OAK sideboard MDF structure,
internal shelves and and pin legs.
cm. l. 185,5 p. 50 h. 88

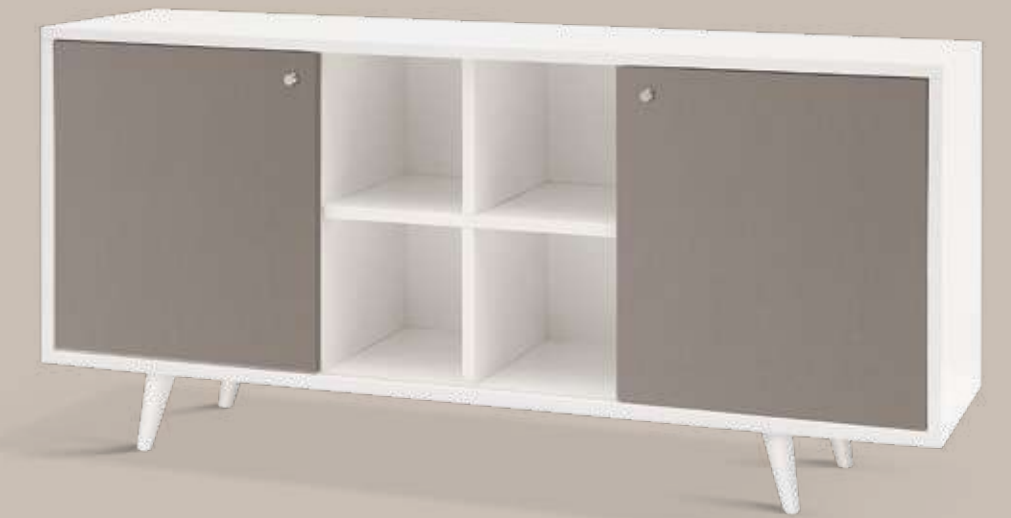

articolo **LF306**
credenza strutturata in MDF ante scorrevoli
in ROVERE, ripiani interni e zoccolo chiuso.
2 sliding doors in OAK sideboard MDF structure,
internal shelves and closed socket.
cm. l. 185,5 p. 50 h. 78



articolo **LF315**
credenza in ROVERE ante scorrevoli,
ripiani interni e zoccolo chiuso.
OAK WOOD sideboard 2 sliding doors,
internal shelves closed socket.
cm. l. 185,5 p. 50 h. 75

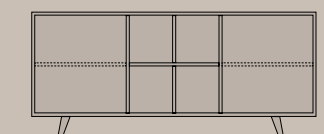

articolo **LF316**
credenza struttura e ante scorrevoli
in ROVERE, ripiani interni e gambe spillo.
OAK WOOD sideboard with structure 2 sliding
doors, internal shelves and pin legs.
cm. l. 185,5 p. 50 h. 85



articolo LF230
sedia in faggio imbottita.
upholstered beech wood chair.
cm. l. 45 p. 50 h. 88 h.s. 48



articolo LF024
tavolo ovale struttura cristallo e rovere,
piano bordo dritto. oval table crystal and oak wood
structure, straight edge top.

misure disponibili: available sizes:

cm. l. 160 p. 110 h. 78

cm. l. 180 p. 120 h. 78

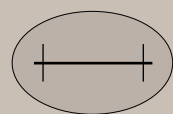

tavolo da cm. l. 160

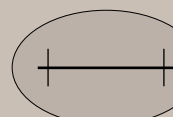

tavolo da cm. l. 180

COLLECTION MYLOFT

articolo LF315
credenza in ROVERE ante scorrevoli,
ripiani interni e zoccolo chiuso.
OAK WOOD sideboard 2 sliding doors,
internal shelves closed socket.
cm. l. 185,5 p. 50 h. 75



articolo LF060

tavolo rettangolare con gambe metallo e piano rovere bordo dritto.
rectangular table with metal legs and oak wood straight edge top.

misure disponibili:
available sizes:

- cm. l. 140 p. 90 h. 79
- cm. l. 160 p. 90 h. 79
- cm. l. 180 p. 90 h. 79
- cm. l. 200 p. 90 h. 79
- cm. l. 220 p. 90 h. 79



articolo LF208Z

sedia con gambe metallo imbottitura City.
chair with metal legs City upholstered.
cm. l. 45 p. 54 h. 90 hs. 49



articolo LF061

tavolo rettangolare con gambe in metallo e piano rovere bordo naturale.
rectangular table with metal legs and oak wood natural edge top.

misure disponibili: available sizes:

- cm. l. 140 p. 90 h. 79
- cm. l. 160 p. 90 h. 79
- cm. l. 180 p. 90 h. 79
- cm. l. 200 p. 90 h. 79
- cm. l. 220 p. 90 h. 79



tavolo da cm. l. 140



tavolo da cm. l. 160



tavolo da cm. l. 180



tavolo da cm. l. 200

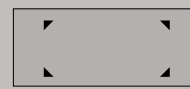

tavolo da cm. l. 220



COLLECTION
MYLOFT



articolo LF300

credenza in rovere 2 ante, ripiani interni e piano in vetro. oak wood sideboard 2 doors, internal shelves and glass top.
cm. l. 120 p. 50 h. 100



articolo LF426
 tavolino ovale e gambe spillo.
 oval coffee table and pin legs.
 cm. l. 120 p. 85 h. 45



articolo LF427
 tavolino rotondo e gambe spillo.
 round coffee table and pin legs.
 cm. l. 80 p. 80 h. 45

articolo LF428
 tavolino rotondo e gambe spillo.
 round coffee table and pin legs.
 cm. l. 60 p. 60 h. 63

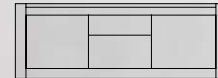

articolo LF405
 madia bassa in ROVERE
 2 porte 1 cassetto. OAK WOOD low
 sideboard 2 doors, 1 drawer.
 cm. l. 144 h. 48 p. 44

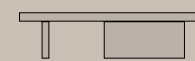

articolo LF422
 tavolino piano e gambe in rovere.
 table top and legs in oak wood.
 cm. l. 120 p. 32 h. 80



COLLECTION
 MYLOFT



articolo **LF400**
credenza in ROVERE 2 porte e ripiani interni.
OAK WOOD sideboard 2 doors, and internal shelves.
cm. l. 112 p. 44 h. 88

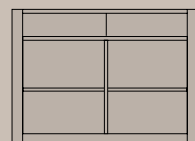

articolo **LF401**
credenza in ROVERE 2 porte 2 cassetti
e ripiani interni. OAK WOOD sideboard 2 doors,
2 drawers and internal shelves.
cm. l. 126 p. 48 h. 90



articolo **LF266**
sedia ecopelle beige con bottoni fusto beige.
beige eco-leather chair with buttons beige frame.
cm. l. 46 p. 45 h. 100 hs. 48



articolo **LF404**
madia in ROVERE 1 ante 2 cassetti, 1 cestone
e ripiano interno. OAK WOOD sideboard 1 door,
2 drawers, 1 big drawer and internal shelf.
cm. l. 152 p. 48 h. 82



COLLECTION
MYLOFT

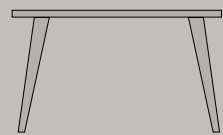

articolo **LF355**
consolle con gambe a spillo e BORDO DRITTO.
console with pin legs and STRAIGHT BORDER.
cm. l. 140 p. 31 h. 81



articolo **FR068**
cornice rotonda traforata specchio liscio.
round perforated frame smooth mirror.
cm. ø. 95 p. 3

articolo **LF356**
consolle con gambe a spillo e BORDO NATURALE.
console with pin legs and NATURAL BORDER.
cm. l. 140 p. 31 h. 81



articolo **FR065**
cornice quadrata traforata specchio liscio.
square perforated frame smooth mirror.
cm. l. 98 sp. 3 h. 98

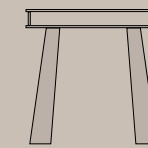

articolo **LF350**
consolle a ribalta con gambe metallo.
flap door console with metal legs.
cm. l. 90 p. 38 h. 90

articolo **LF351**
consolle a ribalta con gambe a spillo.
flap door console with pin legs.
cm. l. 90 p. 38 h. 92

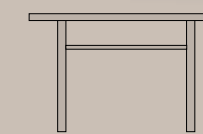
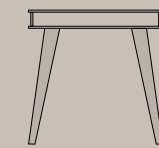

articolo **LF420**
consolle con ripiano inferiore.
console with lower shelf.
cm. l. 130 p. 36 h. 82





articolo **LF358**
 consolle con gambe tornite e piano
 rovere con bordo naturale. console with turned
 legs and oak top with natural edge.
 cm. l. 140 p. 31 h. 76

articolo **FR065**
 cornice quadrata traforata specchio liscio.
 square perforated frame smooth mirror.
 cm. l. 98 sp. 3 h. 98

COLLECTION
MYLOFT



articolo **LF357**
 consolle con gambe tornite e piano
 rovere con bordo dritto. console with turned
 legs and oak top with straight edge.
 cm. l. 140 p. 31 h. 76

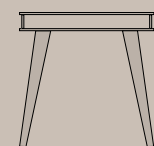

articolo **LF351**
 consolle a ribalta con gambe a spillo.
 flap door console with pin legs.
 cm. l. 90 p. 38 h. 92

articolo **FR068**
 cornice rotonda traforata specchio liscio.
 round perforated frame smooth mirror.
 cm. ø. 95 p. 3

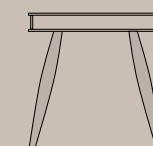

articolo **LF352**
 consolle a ribalta con gambe tornite.
 flap door console with turned legs.
 cm. l. 90 p. 38 h. 87



articolo **LF063**
tavolo ovale con gambe metallo e piano
rovere bordo dritto. oval table with metal
legs and oak wood straight edge top.

misure disponibili: available sizes:

cm. l. 160 p. 110 h. 79

cm. l. 180 p. 120 h. 79

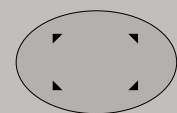

tavolo da cm. l. 160

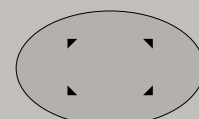

tavolo da cm. l. 180



articolo **LF406**
libreria struttura in metallo 5 ripiani.
metal structure bookcase with 5 shelves.
cm. l. 95 p. 29 h. 220

COLLECTION
MYLOFT



articolo **LF064**
tavolo rotondo con gambe metallo e piano
rovere bordo dritto. round table with metal
legs and oak wood straight edge top.
cm. ø. 110 h. 79

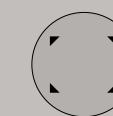

tavolo da cm. ø. 110





articolo LF406
 libreria struttura in metallo 5 ripiani.
 metal structure bookcase with 5 shelves.
 cm. l. 95 p. 29 h. 220

COLLECTION MYLOFT

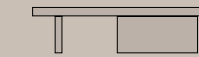

articolo LF422
 tavolino piano e gambe in rovere.
 table top and legs in oak wood.
 cm. l. 120 p. 32 h. 80

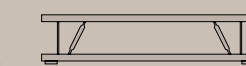
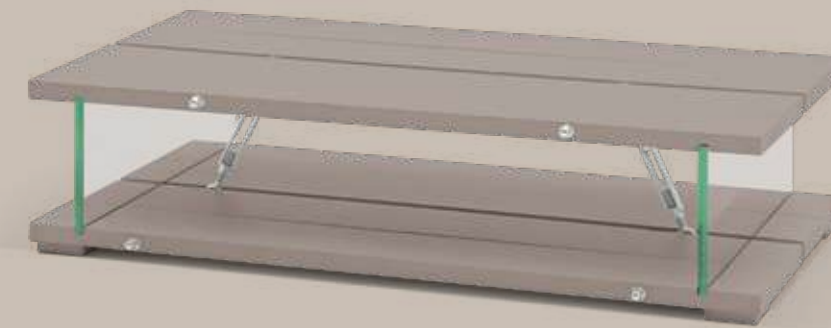

articolo LF425
 tavolino struttura metallo vetro
 piano in rovere. metal glass structure
 coffee table oak top.
 cm. l. 120 p. 31 h. 60



COLLECTION
MYLOFT



articolo LF041
tavolo rettangolare in rovere allungabile
con 2 allunghe da cm. 50. rectangular table
in extendable oak with 2 cm extensions 50.

misure disponibili: available sizes:

cm. l. 160 p. 90 h. 79

cm. l. 180 p. 90 h. 79

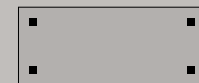

tavolo da cm. l. 180



tavolo da cm. l. 230



tavolo da cm. l. 280



articolo LF403
credenza in listellare di frassino
3 porte 3 cassetti. 3 doors sideboard
in listellar ash wood 3 drawers.
cm. l. 138 p. 48 h. 88

MYLOFT COLLECTION



articolo LF041
tavolo rettangolare in rovere allungabile
con 2 allunghe da cm. 50. rectangular table
in extendable oak with 2 cm extensions 50.



articolo **LF255**
 sedia imbottita ecopelle bianca
 con fusto bianco. white eco-leather
 upholstered chair with white frame.
 cm. l. 46 p. 45 h. 100 h.s. 48

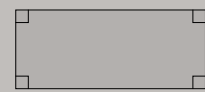

tavolo da cm. 180

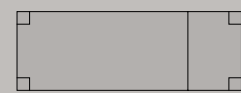

tavolo da cm. 220



tavolo da cm. 260

articolo **LF120**
 tavolo in ROVERE allungabile
 (2 allunghe da cm. 40). extensible table
 in OAK WOOD (2 extensions cm. 40)
 cm. l. 180 p. 90 h. 78



articolo **LF265**
 sedia imbottita ecopelle beige
 con fusto beige. beige eco-leather
 upholstered chair with beige frame.
 cm. l. 46 p. 45 h. 100 h.s. 48



articolo **LF040**
 tavolo in ROVERE allungabile (2 allunghe
 da cm. 50) con gambe inclinate.
 extensible table in OAK WOOD (2 extensions
 cm. 50) with inglinated legs.
 cm. l. 160 p. 90 h. 79

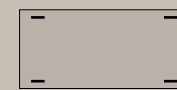

tavolo da cm. 160



tavolo da cm. 210



tavolo da cm. 260



articolo **LF040**
 tavolo in ROVERE allungabile (2 allunghe
 da cm. 50) con gambe inclinate.
 extensible table in OAK WOOD (2 extensions
 cm. 50) with inglinated legs.
 cm. l. 180 p. 90 h. 79

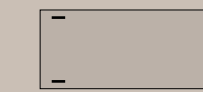

tavolo da cm. 180



tavolo da cm. 230



tavolo da cm. 280





COLLECTION
MYLOFT

articolo **LF832**
basamento tromba in metallo colore nero.
trumpet basement with black metal color.

misure disponibili: available sizes:

cm. ø. 60 h. 72

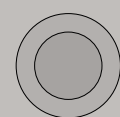

tavolo da cm. ø. 110

64

articolo **LF9009**
piano rotondo in rovere bordo dritto.
round oak top with straight edge.

misure disponibili: available sizes:

cm. ø. 110 sp. 5

articolo **LF9010**
piano rotondo in rovere bordo dritto.
round oak top with straight edge.

misure disponibili: available sizes:

cm. ø. 80 sp. 5

HOMEVENTUNOCOLLECTIONS



articolo **LF831**
basamento tromba in metallo colore bianco.
trumpet basement white metal color.

misure disponibili: available sizes:

cm. ø. 60 h. 72



tavolo da cm. ø. 80

articolo **LF9009**
piano rotondo in rovere bordo dritto.
round oak top with straight edge.

misure disponibili: available sizes:

cm. ø. 110 sp. 5

articolo **LF9010**
piano rotondo in rovere bordo dritto.
round oak top with straight edge.

misure disponibili: available sizes:

cm. ø. 80 sp. 5



articolo **LF240**
sedia in faggio fondino legno.
beech wood chair wooden seat.
cm. l. 40 p. 37 h. 81 hs. 45



articolo **LF242**
sedia in faggio fondino legno.
beech wood chair wooden seat.
cm. l. 40 p. 37 h. 81 hs. 45

HOMEVENTUNOCOLLECTIONS

65



articolo LF263
 sedia ecopelle bianca con bottoni
 fusto bianco. white eco-leather chair
 with buttons white frame.
 cm. l. 46 p. 45 h. 100 hs. 48



articolo LF256
 sedia imbottita ecopelle tortora
 con fusto tortora. dove gray eco leather
 upholstery chair with dove gray stem.
 cm. l. 46 p. 45 h. 100 h.s. 48



articolo LF034
 tavolo ovale struttura rovere, piano rovere
 bordo dritto. oval table oak wood structure,
 straight edge top oak wood.

misure disponibili: available sizes:
 cm. l. 160 p. 110 h. 79
 cm. l. 180 p. 120 h. 79

articolo LF120
 tavolo in ROVERE allungabile
 (2 allunghe da cm. 40). extensible table
 in OAK WOOD (2 extensions cm. 40)
 cm. l. 160 p. 90 h. 78

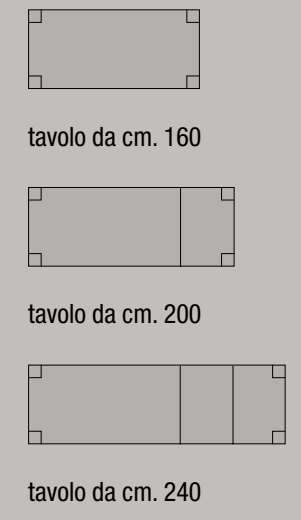

COLLECTION
MYLOFT

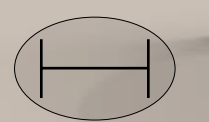



articolo **LF265**
 sedia imbottita ecopelle beige
 con fusto beige. beige eco-leather
 upholstered chair with beige frame.
 cm. l. 46 p. 45 h. 100 h.s. 48



articolo **LF254**
 sedia imbottita ecopelle marrone
 con fusto wengè. brown eco-leather
 upholstered chair with wenge frame.
 cm. l. 46 p. 45 h. 100 h.s. 48



articolo **LF263**
 sedia imbottita ecopelle bianca
 con bottoni fusto bianco. white eco-leather
 upholstered chair with buttons white frame.
 cm. l. 46 p. 45 h. 100 h.s. 48



articolo **LF285**
 sedia imbottita ecopelle invecchiata
 beige con bottoni fusto tortora.
 beige aged eco-leather upholstered chair
 with buttons dove gray frame.
 cm. l. 46 p. 45 h. 100 h.s. 48



articolo **LF286**
 sedia imbottita ecopelle invecchiata
 marrone con bottoni fusto marrone.
 beige aged eco-leather upholstered chair
 brown with buttons brown frame.
 cm. l. 46 p. 45 h. 100 h.s. 48

articolo **LF080**
 tavolo con gambe a colonna
 e piano rovere con bordo dritto.
 table with column legs and oak
 wood top with straight edge.

misure disponibili: available sizes:

cm. l. 140 p. 90 h. 78

cm. l. 160 p. 90 h. 78

cm. l. 180 p. 90 h. 78



tavolo da cm. l. 140



tavolo da cm. l. 160

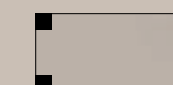

tavolo da cm. l. 180



COLLECTION
MYLOFT



articolo LF269
sedia imbottita ecopelle grigia
con fusto grigio. gray eco-leather
upholstered chair with gray frame.
cm. l. 46 p. 53 h. 99 h.s. 48

articolo LF255
sedia imbottita ecopelle bianca
con fusto bianco. white eco-leather
upholstered chair with white frame.
cm. l. 46 p. 45 h. 100 h.s. 48

articolo LF055
tavolo in rovere sdoppiabile.
double extensible table in oak wood.
cm. l. 120 p. 80 h. 79 chiuso

articolo LF230
sedia in faggio con fondino imbottito.
chair in beech wood with upholstered seat.
cm. l. 45 p. 50 h. 88 h.s. 48



tavolo da cm. 80 x 120



tavoli da cm. 80 x 120 + cm. 80 x 120

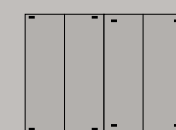

tavolo da cm. 160 x 120

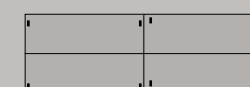

tavolo da cm. 80 x 240



tavolo da cm. 77

articolo LF110
tavolo FISSO in FRASSINO.
fixed table in ASH WOOD.
cm. l. 77 p. 85 h. 78



articolo LF258
sedia imbottita ecopelle beige
con fusto rovere. beige eco-leather
upholstered chair with oak wood frame.
cm. l. 46 p. 45 h. 100 h.s. 48

COLLECTION MYLOFT

TAVOLI MY LOFT LEGNO
E CRISTALLO MY LOFT WOOD
AND CRYSTAL TABLES

piano rovere bordo dritto.
oak wood straight border.



piano rovere bordo naturale.
oak wood top natural border.



piano in cristallo temperato.
tempered glass top.



articolo LF021

tavolo struttura cristallo e rovere, piano in cristallo temperato. table
crystal and oak wood structure, tempered glass top.

misure disponibili:
available sizes:

cm. l. 160 p. 90 h. 79

cm. l. 180 p. 90 h. 79

cm. l. 200 p. 90 h. 79

cm. l. 220 p. 90 h. 79



articolo LF022

tavolo struttura cristallo e rovere, piano bordo dritto.
rectangular table crystal and oak wood structure, top straight border.

misure disponibili:
available sizes:

cm. l. 160 p. 90 h. 79

cm. l. 180 p. 90 h. 79

cm. l. 200 p. 90 h. 79

cm. l. 220 p. 90 h. 79



articolo LF023

tavolo struttura cristallo e rovere, piano bordo naturale.
rectangular table crystal and oak wood structure, natural edge top.

misure disponibili:
available sizes:

cm. l. 160 p. 90 h. 79

cm. l. 180 p. 90 h. 79

cm. l. 200 p. 90 h. 79

cm. l. 220 p. 90 h. 79



articolo LF024

tavolo ovale struttura cristallo e rovere, piano bordo dritto.
oval table crystal and oak wood structure, straight edge top.

misure disponibili:
available sizes:

cm. l. 160 p. 110 h. 78

cm. l. 180 p. 120 h. 78



articolo LF130

struttura cristallo, piano rovere bordo dritto.
crystal structure, oak wood straight border.

misure disponibili:
available sizes:

cm. l. 160 p. 90 h. 78

cm. l. 180 p. 90 h. 78

cm. l. 200 p. 90 h. 78

cm. l. 220 p. 90 h. 78



articolo LF131

struttura cristallo, piano rovere bordo naturale.
crystal structure, oak wood top natural border.

misure disponibili:
available sizes:

cm. l. 160 p. 90 h. 78

cm. l. 180 p. 90 h. 78

cm. l. 200 p. 90 h. 78

cm. l. 220 p. 90 h. 78



articolo LF135

struttura cristallo, piano rovere bordo dritto.
crystal structure, oak wood top straight border.

misure disponibili:
available sizes:

cm. l. 160 p. 110 h. 78

cm. l. 180 p. 120 h. 78



articolo LF140

tavolo in cristallo, piano rovere con bordo dritto.
crystal table, oak wood top with straight edge.

misure disponibili:
available sizes:

cm. l. 160 p. 90 h. 78

cm. l. 180 p. 90 h. 78

cm. l. 200 p. 90 h. 78

cm. l. 220 p. 90 h. 78



articolo LF141

tavolo in cristallo, piano rovere con bordo naturale.
crystal table, oak wood top natural border.

misure disponibili:
available sizes:

cm. l. 160 p. 90 h. 78

cm. l. 180 p. 90 h. 78

cm. l. 200 p. 90 h. 78

cm. l. 220 p. 90 h. 78



articolo LF145

tavolo ovale struttura cristallo, piano rovere bordo dritto.
oval table with crystal structure, straight board oak wood top.

misure disponibili:
available sizes:

cm. l. 160 p. 110 h. 78

cm. l. 180 p. 120 h. 78



articolo LF146

tavolo rotondo struttura cristallo, piano rovere bordo dritto.
round table with crystal structure, straight board oak wood top.

cm. ø. 110 h. 78



articolo LF011

struttura rovere, piano cristallo temperato.
oak wood structure, tempered crystal top.

misure disponibili:
available sizes:

cm. l. 160 p. 90 h. 77

cm. l. 180 p. 90 h. 77

cm. l. 200 p. 90 h. 77

cm. l. 220 p. 90 h. 77

**articolo LF031**

tavolo con struttura in rovere, piano in cristallo temperato.
table structure in oak wood, tempered glass top.

misure disponibili:
available sizes:

cm. l. 160 p. 90 h. 77

cm. l. 180 p. 90 h. 77

cm. l. 200 p. 90 h. 77

cm. l. 220 p. 90 h. 77

**articolo LF012**

tavolo fisso struttura in rovere piano in rovere bordo dritto.
structure oak wood fixed table oak top straight border.

misure disponibili:
available sizes:

cm. l. 160 p. 90 h. 79

cm. l. 180 p. 90 h. 79

cm. l. 200 p. 90 h. 79

cm. l. 220 p. 90 h. 79

**articolo LF032**

tavolo rovere, piano rovere con bordo dritto.
oak wood table, oak wood top with straight edge.

misure disponibili:
available sizes:

cm. l. 160 p. 90 h. 79

cm. l. 180 p. 90 h. 79

cm. l. 200 p. 90 h. 79

cm. l. 220 p. 90 h. 79

**articolo LF013**

tavolo fisso struttura in rovere piano in rovere bordo naturale.
structure oak wood fixed table oak top natural border.

misure disponibili:
available sizes:

cm. l. 160 p. 90 h. 79

cm. l. 180 p. 90 h. 79

cm. l. 200 p. 90 h. 79

cm. l. 220 p. 90 h. 79

**articolo LF033**

tavolo rovere, piano rovere con bordo naturale.
oak wood table, oak wood top with natural edge.

misure disponibili:
available sizes:

cm. l. 160 p. 90 h. 79

cm. l. 180 p. 90 h. 79

cm. l. 200 p. 90 h. 79

cm. l. 220 p. 90 h. 79

**articolo LF014**

tavolo fisso struttura in rovere piano in rovere bordo dritto.
structure oak wood fixed table oak top straight border.

misure disponibili:
available sizes:

cm. l. 160 p. 110 h. 79

cm. l. 180 p. 120 h. 79

**articolo LF014**

tavolo ovale struttura in rovere piano in rovere bordo dritto.
structure oak wood oval table oak top straight border.

misure disponibili:
available sizes:

cm. l. 160 p. 110 h. 79

cm. l. 180 p. 120 h. 79

**articolo LF040**

tavolo rettangolare in rovere allungabile (2 all. da cm.50) con gambe inclinate.
rectangular oak extendable table (2 all. 50 cm.) with inclined legs.

misure disponibili:
available sizes:

cm. l. 160 p. 90 h. 79

cm. l. 180 p. 90 h. 79

**articolo LF041**

tavolo rettangolare in rovere allungabile (2 all. da cm.50).
rectangular oak extendable table (2 all. 50 cm.).

misure disponibili:
available sizes:

cm. l. 160 p. 90 h. 79

cm. l. 180 p. 90 h. 79

**articolo LF041**

tavolo rettangolare in rovere allungabile (2 all. da cm.50).
rectangular oak extendable table (2 all. 50 cm.).

misure disponibili:
available sizes:

cm. l. 160 p. 110 h. 79

cm. l. 180 p. 120 h. 79

**articolo LF50**

tavolo quadrato in rovere allungabile (con 5 allunghe da cm.50 x 90) MAX 340 x 90
square extendable oak table (with 5 extensions 50 x 90 cm.) MAX 340 x 90

misure disponibili:
available sizes:

cm. l. 90 p. 90 h. 76

**articolo LF51**

tavolo rettangolare in rovere allungabile (con 5 allunghe da cm.50 x 80) MAX 370 x 90
rectangular extendable oak table (with 5 extensions 50 x 80 cm.) MAX 370 x 80

misure disponibili:
available sizes:

cm. l. 120 p. 80 h. 76

**articolo LF52**

consolle rettangolare in rovere allungabile (con 5 allunghe da cm.50 x 90) MAX 300 x 90
rectangular extendable oak console (with 5 extensions 50 x 90 cm.) MAX 300 x 80

misure disponibili:
available sizes:

cm. l. 90 p. 50 h. 76

**articolo LF52**

consolle rettangolare in rovere allungabile (con 5 allunghe da cm.50 x 90) MAX 300 x 90
rectangular extendable oak console (with 5 extensions 50 x 90 cm.) MAX 300 x 80

misure disponibili:
available sizes:

cm. l. 90 p. 50 h. 76



articolo **LF55**

tavolo in rovere sdoppiabile (chiuso cm. chiuso l. 120 p. 80 h. 79)
double oak table (closed l. 120 p. 80 h. 79 cm.)

misure disponibili:
available sizes:

cm. l. 120 p. 80 h. 79



aperto. cm. l. 240 p. 80 h. 76,5



aperto. cm. l. 160 p. 120 h. 76,5



aperto. cm. l. 120 p. 80 h. 76,5 (2 tavoli)



articolo **LF070**

tavolo rettangolare con gambe inclinate e piano rovere bordo dritto
rectangular table with inclined legs and oak wood straight edge top.

misure disponibili:
available sizes:

cm. l. 140 p. 90 h. 78

cm. l. 160 p. 90 h. 78

cm. l. 180 p. 90 h. 78



articolo **LF080**

tavolo rettangolare con gambe a colonna e piano rovere bordo naturale.
rectangular table with column legs and oak wood natural edge top.

misure disponibili:
available sizes:

cm. l. 140 p. 90 h. 78

cm. l. 160 p. 90 h. 78

cm. l. 180 p. 90 h. 78



articolo **LF110**

tavolo rettangolare in frassino.
rectangular table in ash wood.

misure disponibili:
available sizes:

cm. l. 77 p. 85 h. 78



articolo **LF120**

tavolo rettangolare in rovere allungabile (2 all. da cm.40).
rectangular oak extendable table (2 all. 40 cm.).

misure disponibili:
available sizes:

cm. l. 160 p. 90 h. 78

cm. l. 180 p. 90 h. 79



articolo **LF100**

tavolo rettangolare con gambe tornite e piano rovere bordo dritto.
rectangular table with turned legs and oak wood straight edge top.

misure disponibili:
available sizes:

cm. l. 140 p. 90 h. 76

cm. l. 160 p. 90 h. 76



articolo **LF101**

tavolo rettangolare con gambe tornite e piano rovere bordo naturale.
rectangular table with turned legs and oak wood natural edge top.

misure disponibili:
available sizes:

cm. l. 140 p. 90 h. 76

cm. l. 160 p. 90 h. 76



articolo **LF103**

tavolo ovale con gambe tornite e piano rovere bordo dritto.
oval table with turned legs and oak wood straight edge top.

misure disponibili:
available sizes:

cm. l. 160 p. 110 h. 76

cm. l. 180 p. 120 h. 76



articolo **LF104**

tavolo rotondo con gambe tornite e piano rovere bordo dritto.
round table with turned legs and oak wood straight edge top.

misure disponibili:
available sizes:

cm.ø. 110 h. 76



articolo **LF105**

tavolo rettangolare con gambe tornite spillo e piano rovere bordo dritto.
rectangular table with pin turned legs and oak wood straight edge top.

misure disponibili:
available sizes:

cm. l. 140 p. 90 h. 81

cm. l. 160 p. 90 h. 81



articolo **LF106**

tavolo rettangolare con gambe tornite spillo e piano rovere bordo naturale.
rectangular table with pin turned legs and oak wood natural edge top.

misure disponibili:
available sizes:

cm. l. 140 p. 90 h. 81

cm. l. 160 p. 90 h. 81



articolo **LF107**

tavolo ovale con gambe tornite spillo e piano rovere bordo dritto.
oval table with pin turned legs and oak wood straight edge top.

misure disponibili:
available sizes:

cm. l. 160 p. 110 h. 81

cm. l. 180 p. 120 h. 81



articolo **LF108**

tavolo rotondo con gambe tornite spillo e piano rovere bordo dritto.
round table with pin turned legs and oak wood straight edge top.

misure disponibili:
available sizes:

cm.ø. 110 h. 81





articolo LF060

tavolo rettangolare con gambe metallo e piano rovere bordo dritto.
rectangular table with metal legs and oak wood straight edge top.

misure disponibili:
available sizes:

cm. l. 140 p. 90 h. 79

cm. l. 160 p. 90 h. 79

cm. l. 180 p. 90 h. 79

cm. l. 200 p. 90 h. 79

cm. l. 220 p. 90 h. 79



articolo LF061

tavolo rettangolare con gambe metallo e piano rovere bordo naturale.
rectangular table with metal legs and oak wood natural edge top.

misure disponibili:
available sizes:

cm. l. 140 p. 90 h. 79

cm. l. 160 p. 90 h. 79

cm. l. 180 p. 90 h. 79

cm. l. 200 p. 90 h. 79

cm. l. 220 p. 90 h. 79



articolo LF63

tavolo ovale con gambe metallo e piano rovere bordo dritto.
oval table with metal legs and oak wood straight edge top.

misure disponibili:
available sizes:

cm. l. 160 p. 110 h. 79

cm. l. 180 p. 120 h. 79



articolo LF64

tavolo rotondo con gambe metallo e piano rovere bordo dritto.
round table with metal legs and oak wood straight edge top.

misure disponibili:
available sizes:

cm. ø. 110 h. 79



articolo LF084

basamento in metallo colore nero, piano rovere con bordo dritto.
black metal basement, oak wood top with straight edge.

misure disponibili:
available sizes:

cm. l. 160 p. 90 h. 79

cm. l. 180 p. 90 h. 79

cm. l. 200 p. 90 h. 79

cm. l. 220 p. 90 h. 79



articolo LF085

basamento in metallo colore nero, piano rovere con bordo naturale.
black metal basement, oak wood top with natural edge.

misure disponibili:
available sizes:

cm. l. 160 p. 90 h. 79

cm. l. 180 p. 90 h. 79

cm. l. 200 p. 90 h. 79

cm. l. 220 p. 90 h. 79



articolo LF086

basamento in metallo colore bianco, piano rovere con bordo dritto.
white metal basement, oak wood top with straight edge.

misure disponibili:
available sizes:

cm. l. 160 p. 90 h. 79

cm. l. 180 p. 90 h. 79

cm. l. 200 p. 90 h. 79

cm. l. 220 p. 90 h. 79



articolo LF087

basamento in metallo colore bianco, piano rovere con bordo naturale.
white metal basement, oak wood top with natural edge.

misure disponibili:
available sizes:

cm. l. 160 p. 90 h. 79

cm. l. 180 p. 90 h. 79

cm. l. 200 p. 90 h. 79

cm. l. 220 p. 90 h. 79



articolo LF831

mento tromba in metallo colore bianco.
pet basement white metal color.

ø. 60 h. 72



articolo LF832

mento tromba in metallo colore nero.
pet basement with black metal color.

ø. 60 h. 72



articolo LF9009

piano rotondo in rovere bordo dritto.
round oak top with straight edge.

cm. ø. 110 sp. 5



articolo LF9010

piano rotondo in rovere bordo dritto.
round oak top with straight edge.

cm. ø. 80 sp. 5



COLLECTION
MYLOFT

TAVOLINI MY LOFT LEGNO
E CRISTALLO MY LOFT WOOD
CRYSTAL COFFEE TABLES

CONSOLLE MY LOFT LEGNO
E METALLO MY LOFT CONSOLE
WOOD AND METAL



articolo **LF422**
tavolino rettangolare con gambe di legno.
rectangular coffee table with wooden legs.
cm. l. 120 p. 80 h. 32



articolo **LF426**
tavolino ovale gambe tornite a spillo.
oval coffee table with spiked legs.
cm. l. 120 p. 85 h. 45



articolo **LF421**
tavolino rettangolare con gambe di vetro.
rectangular coffee table with glass legs.
cm. l. 120 p. 80 h. 28



articolo **LF427**
tavolino rotondo gambe tornite a spillo.
round coffee table with spiked legs.
cm. l. 80 p. 80 h. 45



articolo **LF425**
tavolino rettangolare con vetro e tiranti.
rectangular coffee table with with glass tie rods.
cm. l. 120 p. 60 h. 31



articolo **LF428**
tavolino rotondo gambe tornite a spillo.
round coffee table with spiked legs.
cm. l. 60 p. 60 h. 63



articolo **LF350**
consolle a ribalta con gambe in metallo.
flap door console with metal legs.
cm. l. 90 p. 38 h. 90



articolo **LF351**
consolle a ribalta con gambe tornite a spillo.
flap door console with turned spiked legs.
cm. l. 90 p. 38 h. 92



articolo **LF352**
consolle a ribalta con gambe tornite.
flap door console with turned legs.
cm. l. 90 p. 38 h. 87



articolo **LF420**
consolle con ripiano inferiore.
console with lower shelf.
cm. l. 130 p. 36 h. 82



articolo **LF355**
consolle con gambe tornite a spillo e piano
rovere con bordo dritto. console with pin turned
legs oak wood top with straight edge.
cm. l. 140 p. 31 h. 81



articolo **LF356**
consolle con gambe tornite a spillo e piano
rovere con bordo dritto. console with pin turned
legs oak wood top with natural edge.
cm. l. 140 p. 34 h. 81



articolo **LF357**
consolle con gambe tornite e piano
rovere con bordo dritto. console with turned
legs and oak wood top with straight edge.
cm. l. 140 p. 31 h. 76



articolo **LF358**
consolle con gambe tornite e piano rovere
con bordo naturale. console with turned legs
and oak wood top with natural edge.
cm. l. 140 p. 34 h. 82

COLLECTION
MYLOFT

SEDIE MY LOFT CON
FUSTO LEGNO MY LOFT CHAIRS
WITH WOODEN FRAME



articolo **EC008**
sedia in frassino fondino legno.
ash wood chair wooden seat.
cm. l. 51 p. 51 h. 83 h.s. 45



articolo **EC052**
sedia con fondino legno.
chair with wooden seat.
cm. l. 51 p. 51 h. 83 h.s. 45



articolo **LF200**
sedia in frassino fondino imbottito.
ash wood chair upholstered seat.
cm. l. 68 p. 48 h. 78 h.s. 46



articolo **327G**
sedia in faggio fondino legno.
beech wood chair wooden seat.
cm. l. 43 p. 46 h. 81,5 h.s. 46,5



articolo **327GS**
sgabello in faggio fondino legno.
beech wood stool wooden seat.
cm. l. 39 p. 45 h. 110 h.s. 79



articolo **LF220**
sedia in faggio fondino imbottito.
beech wood chair upholstered seat.
cm. l. 45 p. 50 h. 88 h.s. 48



articolo **LF221**
capotavola in faggio fondino imbottito.
beech wood armchair upholstered seat.
cm. l. 57 p. 50 h. 88 h.s. 48 h.b. 68



articolo **LF222**
sgabello in faggio fondino imbottito.
beech wood stool upholstered seat.
cm. l. 46 p. 49 h. 110 h.s. 79



articolo **LF230**
sedia in faggio imbottita.
upholstered beech wood chair.
cm. l. 45 p. 50 h. 88 h.s. 48



articolo **LF231**
capotavola in faggio imbottito.
upholstered beech wood armchair.
cm. l. 57 p. 50 h. 88 h.s. 48 h.b. 68



articolo **LF232**
sgabello in faggio imbottito.
upholstered beech wood stool.
cm. l. 46 p. 49 h. 110 h.s. 79



articolo **LF235**
sedia in faggio fondino imbottito.
beech wood chair upholstered seat.
cm. l. 41 p. 46,5 h. 87 h.s. 45,5



articolo **LF236**
sgabello in faggio fondino imbottito.
beech wood stool upholstered seat.
cm. l. 41,5 p. 47 h. 109 h.s. 80



articolo **LF238**
sgabello in faggio fondino imbottito.
beech wood stool upholstered seat.
cm. l. 41,5 p. 47 h. 109 h.s. 80



articolo **LF239**
sedia in faggio imbottita.
upholstered beech wood chair.
cm. l. 41 p. 46,5 h. 87 h.s. 45,5



articolo **LF240**
sedia in faggio fondino legno.
beech wood chair wooden seat.
cm. l. 40 p. 37 h. 81 h.s. 45



articolo **LF242**
sedia in faggio fondino legno.
beech wood chair wooden seat.
cm. l. 40 p. 37 h. 81 h.s. 45



articolo **LF245**
sedia con fondino imbottito
impilabile in faggio. beech wood chair
with upholstered seat stackable.
cm. l. 45 p. 48 h. 83 h.s. 47



articolo **LF246**
sedia con fondino imbottito
impilabile in faggio. beech wood chair
with upholstered seat stackable.
cm. l. 45 p. 48 h. 83 h.s. 46



articolo **326G**
sedia in faggio fondino legno.
beech wood chair wooden seat.
cm. l. 43 p. 46 h. 81,5 h.s. 46,5



articolo **326GS**
sgabello in faggio fondino legno.
beech wood stool wooden seat.
cm. l. 39 p. 45 h. 110 h.s. 79



articolo **750/G**
fusto da imbottire.
chair frame for upholstered.
cm. l. 50 p. 50 h. 104 h.s. 43

COLLECTION
MYLOFT

SEDIE MY LOFT CON GAMBE
METALLO MY LOFT CHAIRS
WITH METAL LEGS



articolo LF206Z
sedia con gambe metallo
imbottitura Time. chair with metal
legs Time upholstered.
cm. l. 45 p. 54 h. 90 h.s. 49



articolo LF207Z
sedia con gambe metallo
imbottitura Inghilterra. chair with metal
legs England upholstered.
cm. l. 45 p. 54 h. 90 h.s. 49



articolo LF208Z
sedia con gambe metallo
imbottitura City. chair with metal
legs City upholstered.
cm. l. 45 p. 54 h. 90 h.s. 49



articolo LF209Z
sedia con gambe metallo imbottita
ecopelle panna. chair with metal
legs upholstered cream eco-leather.
cm. l. 45 p. 54 h. 90 h.s. 49

COLLECTION
MYLOFT

SEDIE MY LOFT LEGNO
ECOPELLE MY LOFT WOOD
ECO-LEATHER CHAIRS



articolo LF254
sedia imbottita ecopelle marrone
con fusto wengè. brown eco-leather
upholstered chair with wenge frame.
cm. l. 46 p. 45 h. 100 h.s. 48



articolo LF255
sedia imbottita ecopelle bianca
con fusto bianco. white eco-leather
upholstered chair with white frame.
cm. l. 46 p. 45 h. 100 h.s. 48



articolo LF256
sedia imbottita ecopelle tortora
con fusto tortora. taupe eco-leather
upholstered chair with taupe frame.
cm. l. 46 p. 45 h. 100 h.s. 48



articolo LF257
sedia imbottita ecopelle bianca
con fusto rovere. white eco-leather
upholstered chair with oak wood frame.
cm. l. 46 p. 45 h. 100 h.s. 48



articolo LF258
sedia imbottita ecopelle beige
con fusto rovere. beige eco-leather
upholstered chair with oak wood frame.
cm. l. 46 p. 45 h. 100 h.s. 48



articolo LF259
sedia imbottita ecopelle grigia
con fusto grigio. gray eco-leather
upholstered chair with gray frame.
cm. l. 46 p. 45 h. 100 h.s. 48



articolo LF265
sedia imbottita ecopelle beige
con fusto beige. beige eco-leather
upholstered chair with beige frame.
cm. l. 46 p. 45 h. 100 h.s. 48



articolo LF269
sedia imbottita ecopelle antracite
fusto antracite. anthracite eco-leather
upholstered chair anthracite frame.
cm. l. 46 p. 45 h. 100 h.s. 48

COLLECTION
MYLOFT

SEDIE MY LOFT ECOPELLE
CON BOTTONI MY LOFT ECO-LEATHER
CHAIRS WITH BUTTONS



articolo LF260
sedia ecopelle beige con bottoni
fusto bianco. beige eco-leather chair
with buttons white frame.
cm. l. 46 p. 45 h. 100 h.s. 48



articolo LF261
sedia ecopelle marrone con bottoni
fusto wengè. brown eco-leather chair
with buttons wenge frame.
cm. l. 46 p. 45 h. 100 h.s. 48



articolo LF262
sedia ecopelle tortora con bottoni
fusto tortora. dove gray eco-leather
chair with buttons dove gray frame.
cm. l. 46 p. 45 h. 100 h.s. 48

COLLECTION
MYLOFT

SEDIE MY LOFT ECOPELLE
CON BOTTONI MY LOFT ECO-LEATHER
CHAIRS WITH BUTTONS



articolo LF263
sedia ecopelle bianca con bottoni
fusto bianco. white eco-leather chair
with buttons white frame.
cm. l. 46 p. 45 h. 100 h.s. 48



articolo LF264
sedia ecopelle beige con bottoni
fusto rovere. beige eco-leather chair
with buttons oak wood frame.
cm. l. 46 p. 45 h. 100 h.s. 48



articolo LF266
sedia ecopelle beige con bottoni
fusto beige. beige eco-leather chair
with buttons beige frame.
cm. l. 46 p. 45 h. 100 h.s. 48

COLLECTION
MYLOFT

SEDIE MY LOFT ECOPELLE
INVECCHIATA MUSTANG
MY LOFT ECO-LEATHER
CHAIRS AGED MUSTANG



articolo LF280
sedia ecopelle invecchiata beige
con fusto tortora. beige aged
eco-leather chair with dove gray frame.
cm. l. 46 p. 45 h. 100 h.s. 48



articolo LF281
sedia ecopelle invecchiata marrone
con fusto marrone. brown aged
eco-leather chair with brown frame.
cm. l. 46 p. 45 h. 100 h.s. 48



articolo LF282
sedia ecopelle invecchiata grigia
con fusto grigio. gray aged
eco-leather chair with gray frame.
cm. l. 46 p. 45 h. 100 h.s. 48

COLLECTION
MYLOFT

SEDIE MY LOFT ECOPELLE
INVECCHIATA MUSTANG CON BOTTONI
MY LOFT ECO-LEATHER CHAIRS
AGED MUSTANG WITH BUTTONS



articolo LF285
sedia ecopelle invecchiata
beige con bottoni fusto tortora.
beige aged eco-leather chair
with buttons dove gray frame.
cm. l. 46 p. 45 h. 100 h.s. 48



articolo LF286
sedia ecopelle invecchiata marrone
con bottoni fusto marrone.
beige aged eco-leather chair brown
with buttons brown frame.
cm. l. 46 p. 45 h. 100 h.s. 48



articolo LF287
sedia ecopelle invecchiata grigia
con bottoni fusto grigio.
beige aged eco-leather chair gray
with buttons gray frame.
cm. l. 46 p. 45 h. 100 h.s. 48

COLLECTION
MYLOFT

SGABELLI MY LOFT
LEGNO ECOPELLE
MY LOFT WOOD ECO-
LEATHER STOOLS



articolo LF243
sgabello ecopelle marrone
con fusto wengè. brown eco-leather
stool with wenge frame.
cm. l. 48 p. 49 h. 115 h.s. 74



articolo LF244
sgabello ecopelle beige
con fusto rovere. beige eco-leather
stool with oak wood frame.
cm. l. 48 p. 49 h. 115 h.s. 74



articolo LF247
sgabello ecopelle antracite
con fusto antracite. anthracite eco-
leather stool with anthracite frame.
cm. l. 48 p. 49 h. 115 h.s. 74



articolo LF248
sgabello ecopelle tortora
con fusto tortora. dove gray eco-leather
stool with dove gray frame.
cm. l. 48 p. 49 h. 115 h.s. 74



articolo LF251
sgabello ecopelle beige
con fusto bianco. beige eco-leather
stool with white frame.
cm. l. 48 p. 49 h. 115 h.s. 74

CREDENZE E VETRINE MY LOFT
IN ROVERE CON ZOCCOLO
MY LOFT SIDEBORD SHOWCASE
IN OAK WITH BASEBOARD



articolo **LF325**
credenza 4 porte struttura
in rovere con zoccolo. sideboard 4 doors
oak structure with baseboards.
cm. l. 185,5 p. 50 h. 75



articolo **LF315**
credenza struttura in rovere con ante scorrevoli
in rovere e zoccolo. sideboard oak structure
with 2 oak sliding doors and baseboards.
cm. l. 185,5 p. 50 h. 75



articolo **LF330**
vetrina 1 porta rovere 1 porta
vetro con zoccolo. showcase 1 oak door
1 glass door with baseboards.
cm. l. 100 p. 50 h. 134



articolo **LF340**
vetrina 1 porta sinistra vetro con zoccolo.
showcase 1 leaf glass door with baseboards.
cm. l. 55 p. 45 h. 189



articolo **LF341**
vetrina 1 porta destra vetro con zoccolo.
showcase 1 right glass door with baseboards.
cm. l. 55 p. 45 h. 189



articolo **LF345**
vetrina 1 porta sinistra vetro
2 cassetti con zoccolo. showcase 1 leaf
glass door 2 drawers with baseboards.
cm. l. 55 p. 45 h. 189



articolo **LF346**
vetrina 1 porta destra vetro
2 cassetti con zoccolo. showcase 1 right
glass door 2 drawers with baseboards.
cm. l. 55 p. 45 h. 189

CREDENZE E VETRINE MY LOFT
IN ROVERE CON GAMBE A SPILLO TORNITE
MY LOFT SIDEBORD SHOWCASE
IN OAK WITH PIN TURNED LEGS



articolo **LF326**
credenza 4 porte struttura in rovere
con gambe tornite a spillo. sideboard 4 doors
oak structure with pin turned legs.
cm. l. 185,5 p. 50 h. 85



articolo **LF316**
credenza struttura in rovere con ante scorrevoli
in rovere e gambe tornite a spillo. sideboard oak
structure with 2 oak slid. doors and pin turned legs.
cm. l. 185,5 p. 50 h. 85



articolo **LF331**
vetrina 1 porta rovere 1 porta vetro
con gambe tornite a spillo. showcase 1 oak
door 1 glass door with pin turned legs.
cm. l. 100 p. 50 h. 144



art. **LF342**
vetrina 1 porta sinistra vetro con
gambe tornite a spillo. showcase 1 leaf
glass door with pin turned legs.
cm. l. 55 p. 45 h. 199



art. **LF343**
vetrina 1 porta destra vetro con
gambe tornite a spillo. showcase 1 right
glass door with pin turned legs.
cm. l. 55 p. 45 h. 199



art. **LF347**
vetrina 1 porta sinistra vetro 2 cassetti
con gambe tornite a spillo. showcase 1 leaf
glass door 2 drawers with pin turned legs.
cm. l. 55 p. 45 h. 199



art. **LF348**
vetrina 1 porta destra vetro 2 cassetti
con gambe tornite a spillo. showcase 1 right
glass door 2 drawers with pin turned legs.
cm. l. 55 p. 45 h. 199

CREDENZE E PORTA TV MY LOFT
CON STRUTTURA IN ROVERE
O MDF ANTE IN ROVERE
MY LOFT SIDEBORD AND
TV STAND WITH OAK OR MDF
STRUCTURE OAK DOORS



articolo **LF314**
porta TV struttura e ante scorrevoli
in rovere con zoccolo. TV stand structure
and sliding doors in oak with baseboards.
cm. l. 185,5 p. 50 h. 54,5



articolo **LF309**
porta TV struttura e ante scorrevoli
in rovere con zoccolo. TV stand structure
and sliding doors in oak with baseboards.
cm. l. 185,5 p. 50 h. 44,5



articolo **LF316**
credenza con struttura ante scorrevoli in rovere
e gambe tornite a spillo. sideboard with structure
sliding doors in oak and pin turned legs.
cm. l. 185,5 p. 50 h. 88



articolo **LF306**
credenza struttura in MDF ante scorrevoli
in rovere con zoccolo. sideboard MDF structure
and sliding doors in oak with baseboards.
cm. l. 185,5 p. 50 h. 78



articolo **LF312**
porta TV struttura in MDF ante scorrevoli
in rovere con zoccolo. TV stand MDF structure
and sliding doors in oak with baseboards.
cm. l. 185,5 p. 50 h. 54,5



articolo **LF311**
porta TV struttura in MDF ante scorrevoli
in rovere con zoccolo. TV stand MDF structure
and sliding doors in oak with baseboards.
cm. l. 185,5 p. 50 h. 44,5

PENSILI MY LOFT STRUTTURA MDF
MY LOFT HANGING MDF STRUCTURE



articolo **MB152**
pensile a giorno struttura.
compartement hanging MDF structure.
cm. l. 40 p. 17 h. 40



articolo **MB154**
pensile a giorno struttura.
compartement hanging MDF structure.
cm. l. 20 p. 17 h. 80

COLLECTION
MYLOFT

CREDENZE MY LOFT
LISTELLARE FRASSINO
MY LOFT SIDEBOARD
LISTELLAR ASH WOOD



articolo LF401
credenza in listellare di frassino
2 porte 2 cassetti. 2 doors sideboard
in listellar ash wood 2 drawers.
cm. l. 126 p. 48 h. 90



articolo LF400
credenza in listellare di frassino
2 porte. 2 doors sideboard
in listellar ash wood.
cm. l. 112 p. 44 h. 88



articolo LF404
credenza in listellare di frassino
1 porta 3 cassetti. 1 door sideboard
in listellar ash wood 3 drawers.
cm. l. 152 p. 48 h. 82



articolo LF403
credenza in listellare di frassino
3 porte 3 cassetti. 3 doors sideboard
in listellar ash wood 3 drawers.
cm. l. 138 p. 48 h. 88



articolo LF405
porta TV in listellare di frassino
2 porte 1 cassetto. 2 doors sideboard
in listellar ash wood 1 drawer.
cm. l. 144 p. 44 h. 48



articolo LF300
credenza in rovere 2 porte.
2 doors oak wood sideboard.
cm. l. 120 p. 50 h. 100

COLLECTION
MYLOFT

LIBRERIA E SPECCHIERE
MY LOFT MY LOFT BOOKCASE
AND FRAME



articolo LF406
libreria struttura in metallo 5 ripiani.
metal structure bookcase with 5 shelves.
cm. l. 95 p. 29 h. 220



articolo FR065
cornice quadrata traforata specchio liscio.
square perforated frame smooth mirror.
cm. l. 98 sp. 3 h. 98



articolo FR068
cornice rotonda traforata specchio liscio.
round perforated frame smooth mirror.
cm. ø. 95 p. 3

COLLECTIONS
NATURALCHIC

NATURAL CHIC LE NUOVE TENDENZE D'ARREDAMENTO
THE NEW FURNISHING TRENDS NATURAL CHIC



STILE NATURAL CHIC ARREDAMENTO. Idee per arredare i diversi ambienti di casa. Mobili e complementi forme e colori. Lo stile NATURAL chic è una tendenza in voga per rinnovare in maniera particolare gli ambienti di casa, quando si vuole uscire dai canoni classici ed introdurre elementi delle culture lontane come quelle africane ed orientali, spesso conosciute durante le vacanze estive. Lo stile attinge dalle culture di paesi lontani, inserire il fascino chic permette di avere soluzioni ideali per gli ambienti di casa, vivibili e piacevoli alla vista in virtù dei colori e le trame particolari. La parte principale è svolta dal legno, materiale naturale attualmente principale elemento nelle culture africane per realizzare mobili come il letto, tavoli e sedie. Nella cultura afro, le figure hanno un alto valore simbolico: il legno, a differenza di altri materiali, è ideale per rappresentare momenti di vita.

ETHNIC CHIC STYLE FURNITURE. Ideas for decorating the different rooms of the house. Furniture and accessories, shapes and colors. The NATURAL chic style is a trend in vogue to renew the home environments in a particular way, when you want to get out of the classic canons and introduce elements of distant cultures such as African and oriental ones, often known during the summer holidays. The style draws from the cultures of distant countries, inserting the chic charm allows you to have ideal solutions for home environments, livable and pleasing to the eye thanks to the particular colors and textures. The main part is carried out by wood, a natural material currently the main element in African cultures to make furniture such as the bed, tables and chairs. In Afro culture, figures have a high symbolic value: wood, unlike other materials, is ideal for representing moments of life.



progetto E.CHIC 1
parete componibile a moduli.
modular living room.



COLLECTION NATURALCHIC

articolo EC-004
libreria a giorno con 4 ripiani in vetro e kit
faretti 3 luci cromo. open bookcase with 4 glass
shelves and spotlights kit 3 chrome lights.
cm. l. 110 p. 36 h. 202





COLLECTION
NATURALCHIC

articolo EC-001
credenza 2 ante battenti 3 cassetti.
sideboard 2 hinged doors 3 drawers.
cm. l. 248 p. 45 h. 95

articolo 327G
sedia in faggio fondino legno.
beech wood chair wooden seat.
cm. l. 43 p. 46 h. 81,5 h.s. 46,5

articolo 327/GS
sgabello in faggio fondino legno.
beech wood stool wooden seat.
cm. l. 39 p. 45 h. 110 h.s. 79



articolo EC-054
vetrina 2 ante vetro. showcase 2 glass doors.
cm. l. 128 p. 36 h. 202





articolo EC-070
credenza 2 porte 2 cassetti.
2 doors sideboard 2 drawers.
cm. l. 160 p. 45 h. 104



articolo EC-006
dispensa 4 porte legno. 2 wooden doors pantry.
cm. l. 168 p. 45 h. 175

COLLECTION
NATURALCHIC

COLLECTION
NATURAL CHIC



progetto E.CHIC 4
parete componibile a moduli.
modular living room.

articolo EC-013
pensile a giorno con ripiani.
compartements hanging with shelves.
cm. l. 100 p. 22 h. 100

articolo EC-021
base 2 cassetti. 2 drawers base.
cm. l. 168 p. 60 h. 59

articolo EC-058
dispensa 1 porta legno 1 porta vetro.
1 wooden door pantrie 1 glass door.
cm. l. 88 p. 45 h. 175





articolo EC-007B
tavolo rettangolare fisso. rectangular fixed table.
cm. l. 160 p. 95 h. 80

articolo EC-065
cassettiera 7 cassetti. drawers 7 drawers.
cm. l. 80 p. 45 h. 130

articolo EC014
pensile a giorno con ripiani.
compartements hanging with shelves.
cm. l. 50 p. 22 h. 100

articolo EC-015
mensola da cm. 100. shelf cm. 100.
cm. l. 100 p. 22 sp. 3

articolo EC-038
tavolino con vano a giorno.
open compartment coffee table.
cm. l. 80 p. 45 h. 45

articolo EC-054
vetrina 2 ante vetro. showcase 2 glass doors.
cm. l. 128 p. 36 h. 202

articolo LF258
sedia imbottita ecopelle beige.
beige eco-leather upholstered chair.
cm. l. 46 p. 45 h. 100 h.s. 48

SMART WORKING

Lavorare da casa senza uscire per andare in ufficio è un requisito divenuto sempre più importante. Un locale studio, ma anche solo un lato dell'ambiente preferito si trasforma facilmente in una pratica e attrezzata area di lavoro anche in forma stabile.

Working from home without leaving for the office is a requirement that has become increasingly important. A study room, but even just one side of the preferred environment, easily transforms into a practical and well-equipped work area even in a stable form.



COLLECTION
NATURALCHIC



COLLECTION
NATURAL CHIC

DEDICATO A CHI AMA LASCIARSI CONQUISTARE.
UNO STILE COSTRUITO PEZZO PER PEZZO, CON GRANDE
ATTENZIONE AI DETTAGLI E ALLE FINITURE, SEMPRE
CONTRASSEGNA TO DALLA PASSIONE E DALLA CONOSCENZA
DEL LEGNO NELLE SUE TANTE ESSENZE.
DEDICATED TO THOSE WHO LIKE TO BE CONQUERED.
A STYLE BUILT PIECE BY PIECE, WITH GREAT ATTENTION TO
DETAILS AND FINISHES, ALWAYS MARKED BY THE PASSION AND
KNOWLEDGE OF WOOD IN ITS MANY ESSENCES.

articolo **EC-005**
dispensa 2 porte legno 2 porte vetro.
2 wooden doors pantrie 2 glass doors.
cm. l. 168 p. 45 h. 175

articolo **EC-009**
pensile 2 porte e vani a giorno.
2 doors hanging and compartements.
cm. l. 248 p. 33 h. 68

articolo **EC-019**
base con vano a giorno.
base with compartement.
cm. l. 200 p. 60 h. 41

articolo EC-002
credenza con 2 porte. sideboard with 2 doors.
cm. l. 168 p. 45 h. 95



articolo EC-021
base 2 cassetti. 2 drawers base.
cm. l. 168 p. 60 h. 59



COLLECTION
NATURALCHIC

articolo EC-022
base con vano a giorno.
base with compartement.
cm. l. 160 p. 60 h. 41



COLLECTION NATURALCHIC

articolo EC-052
sedia con fondino legno. chair with wooden seat.
cm. l. 68 p. 48 h. 78 hs. 78

articolo EC-007
tavolo rettangolare fisso. rectangular fixed table.
cm. l. 220 p. 95 h. 80



ART. EC-008
sedia con fondino legno.
chair with wooden seat.
cm. l. 51 p. 51 h. 83 hs. 45

ART. EC-007
tavolo rettangolare fisso.
rectangular fixed table.
cm. l. 120 p. 95 h. 80

ART. EC-002
credenza con 2 porte.
sideboard with 2 doors.
cm. l. 168 p. 45 h. 95





articolo **EC-055**
vetrina 1 porta destra ripiani in cristallo.
1 right door showcase crystal shelves.
cm. l. 72 p. 36 h. 202

articolo **EC-056**
vetrina 1 porta sinistra ripiani in cristallo.
1 leaf door showcase crystal shelves.
cm. l. 72 p. 36 h. 202



articolo **LF200**
sedia in frassino fondino imbottito.
ash wood chair upholstered seat.
cm. l. 68 p. 48 h. 78 h.s. 46

articolo **EC-001**
credenza 2 porte 1 cestone 2 cassetti.
2 doors sideboard 1 big drawer 2 draws.
cm. l. 248 p. 45 h. 95

articolo **EC-007**
tavolo rettangolare fisso. rectangular fixed table.
cm. l. 220 p. 95 h. 80

COLLECTION
NATURALCHIC

NATURALCHIC COLLECTION

COLLECTION NATURALCHIC

articolo EC-001
credenza 2 porte 1 cestone 2 cassetti.
2 doors sideboard 1 big drawer 2 draws.
cm. l. 248 p. 45 h. 95

articolo EC-007
tavolo rettangolare fisso. rectangular fixed table.
cm. l. 220 p. 95 h. 80

articolo EC-052
sedia con fondino legno. chair with wooden seat.
cm. l. 51 p. 51 h. 83 h.s. 45

articolo EC-025
tavolino quadrato con ripiano.
square coffee table with shelf.
cm. l. 45 p. 45 h. 100

articolo EC-054
vetrina 2 porte ripiani in cristallo.
2 doors showcase crystal shelves.
cm. l. 128 p. 36 h. 202

ELEGANZA DEL VIVERE QUOTIDIANO

Il caratteristico motivo (con giunte diagonali in legno a 45°, di abile falegnameria) distingue tutta la collezione NATURAL CHIC evidenziando in ogni dettaglio la massima personalizzazione delle linee d'arredo.

ELEGANCE OF EVERYDAY LIVING

The characteristic motif (with 45° diagonal wooden joints, of skilled carpentry) distinguishes the entire NATURAL CHIC collection, highlighting in every detail the maximum customization of the furniture lines.



Una volta messa in posizione ogni allunga collega le parti del tavolo creando la sua perfetta continuità anche sul perimetro dei fianchi.

Once placed in position, each extension connects the sides of the table, creating its perfect continuity even on the perimeter of the sides.

AGGIUNGI UN POSTO A TAVOLA

la cura dei dettagli costruttivi è dedicata ai veri intenditori d'arredo in legno e ai graditi ospiti destinatari dell'accoglienza.

ADD A PLACE AT THE TABLE

the attention to construction details is dedicated to true expert of wooden furniture and welcome guests.

COLLECTION NATURALCHIC

articolo EC-007
tavolo rettangolare fisso. rectangular fixed table.
cm. l. 220 p. 95 h. 80

articolo EC-007/B
tavolo rettangolare fisso. rectangular fixed table.
cm. l. 160 p. 95 h. 80

articolo EC-007/C
tavolo rettangolare fisso. rectangular fixed table.
cm. l. 120 p. 95 h. 80

articolo EC-007/D
tavolo rettangolare con 2 allunghe da cm. 40.
rectangular table with 2 extensions of cm. 40.
cm. l. 120/200 p. 95 h. 80



SEMPLICE TRASFORMAZIONE, ESTETICA PERFETTA

I tavoli allungabili sono prontamente trasformati nella lunghezza desiderata con apposite allunghe dai fianchetti laterali pieghevoli. una volta utilizzata in posizione aperta, collega le parti del tavolo creando la perfetta continuità anche sui fianchi ed in tutto il suo perimetro.

SIMPLE TRANSFORMATION, PERFECT AESTHETICS

The extendable tables are promptly transformed into the desired length with special extensions with folding side panels. once used in the open position, it connects the parts of the table creating perfect continuity also on the sides and throughout its perimeter.



articolo EC-008
sedia con fondino legno. chair with wooden seat.
cm. l. 51 p. 51 h. 83 h.s. 45



articolo EC-052
sedia con fondino legno. chair with wooden seat.
cm. l. 51 p. 51 h. 83 h.s. 45



articolo LF200
sedia in frassino fondino imbottito.
ash wood chair upholstered seat.
cm. l. 68 p. 48 h. 78 h.s. 46

articolo EC-012
pensile 4 porte. 4 doors hanging.
cm. l. 128 p. 33 h. 68

articolo EC-050
base 2 cassetti e vano.
2 drawers base and compartem.
cm. l. 148 p. 45 h. 59



COLLECTION
NATURALCHIC



articolo EC-011
pensile 4 porte. 4 doors hanging.
cm. l. 128 p. 33 h. 128

articolo EC-018
base 2 cestoni 2 cassetti.
2 big drawers base 2 drawers.
cm. l. 248 p. 60 h. 59

articolo EC-025
tavolino quadrato con ripiano.
square coffee table with shelf.
cm. l. 45 p. 45 h. 100

articolo EC-050
base 2 cassetti e vano.
2 drawers base and compartem.
cm. l. 148 p. 45 h. 59

articolo EC-055
vetrina 1 porta destra ripiani in cristallo.
1 right door showcase crystal shelves.
cm. l. 72 p. 36 h. 202

articolo EC-056
vetrina 1 porta sinistra ripiani in cristallo.
1 leaf door showcase crystal shelves.
cm. l. 72 p. 36 h. 202



DEDICATO A CHI AMA LASCIARSI CONQUISTARE.
UNO STILE COSTRUITO PEZZO PER PEZZO, CON GRANDE
ATTENZIONE AI DETTAGLI E ALLE FINITURE, SEMPRE
CONTRASSEGNA TO DALLA PASSIONE E DALLA CONOSCENZA
DEL LEGNO NELLE SUE TANTE ESSENZE.
DEDICATED TO THOSE WHO LIKE TO BE CONQUERED.
A STYLE BUILT PIECE BY PIECE, WITH GREAT ATTENTION TO
DETAILS AND FINISHES, ALWAYS MARKED BY THE PASSION AND
KNOWLEDGE OF WOOD IN ITS MANY ESSENCES.

COLLECTION NATURALCHIC



articolo EC-005
dispensa 2 porte legno 2 porte vetro.
2 wooden doors pantrie 2 glass doors.
cm. l. 168 p. 45 h. 175

articolo EC-024
tavolino quadrato con ripiano.
square coffee table with shelf.
cm. l. 90 p. 90 h. 45

articolo EC-025
tavolino quadrato con ripiano in cristallo.
square coffee table with crystal shelf.
cm. l. 45 p. 45 h. 100



COLLECTION NATURALCHIC

articolo EC-009
pensile 2 porte e vani a giorno.
2 doors hanging and compartements.
cm. l. 248 p. 33 h. 68

articolo EC-018
base 2 cestoni 2 cassetti.
2 big drawers base 2 drawers.
cm. l. 248 p. 60 h. 59



STILE NATURAL CHIC ARREDAMENTO. Idea per arredare i diversi ambienti di casa. Mobili e complementi forme e colori. Lo stile NATURAL chic è una tendenza in voga per rinnovare in maniera particolare gli ambienti di casa, quando si vuole uscire dai canoni classici ed introdurre elementi delle culture lontane come quelle africane ed orientali, spesso conosciute durante le vacanze estive. Lo stile attinge dalle culture di paesi lontani, inserire il fascino chic permette di avere soluzioni ideali per gli ambienti di casa, vivibili e piacevoli alla vista in virtù dei colori e le trame particolari. La parte principale è svolta dal legno, materiale naturale attualmente principale elemento nelle culture africane per realizzare mobili come il letto, tavoli e sedie. Nella cultura afro, le figure hanno un alto valore simbolico: il legno, a differenza di altri materiali, è ideale per rappresentare momenti di vita.

ETHNIC CHIC STYLE FURNITURE. Ideas for decorating the different rooms of the house. Furniture and accessories, shapes and colors. The NATURAL chic style is a trend in vogue to renew the home environments in a particular way, when you want to get out of the classic canons and introduce elements of distant cultures such as African and oriental ones, often known during the summer holidays. The style draws from the cultures of distant countries, inserting the chic charm allows you to have ideal solutions for home environments, livable and pleasing to the eye thanks to the particular colors and textures. The main part is carried out by wood, a natural material currently the main element in African cultures to make furniture such as the bed, tables and chairs. In Afro culture, figures have a high symbolic value: wood, unlike other materials, is ideal for representing moments of life.

COLLECTIONS

NATURALCHICNIGHT

NATURAL CHIC LE NUOVE TENDENZE D'ARREDAMENTO
THE NEW FURNISHING TRENDS NATURAL CHIC



NATURALCHICNIGHT



articolo EC-028
letto matrimoniale senza testata.
double bed with no headboard.
cm. l. 186 p. 215 h. 22

articolo EC-034
comò doppio con 6 cassetti.
4 drawers double chest of drawers.
cm. l. 160 p. 50 h. 77

articolo EC-036
comodino con 2 cassetti.
2 drawers bedside table.
cm. l. 80 p. 45 h. 45





COLLECTION
NATURALCHIC

articolo EC-026
letto matrimoniale con testata legno.
double bed with wooden headboard.
cm. l. 186 p. 215 h. 22/80

articolo EC-031
armadio 2 ante scorrevoli
+KIT PANNELLI LEGNO. wardrobe 2 sliding
doors+WOODEN PANEL KIT.
cm. l. 280 p. 65 h. 250

articolo EC-036
comodino con 2 cassetti.
2 drawers bedside table.
cm. l. 80 p. 45 h. 45



articolo EC-031
 armadio 2 ante scorrevoli+KIT PANNELLI LEGNO.
 wardrobe 2 sliding doors+WOODEN PANEL KIT.
 cm. l. 280 p. 65 h. 250

COLLECTION
NATURALCHIC

ATTREZZATURA INTERNA COMPLETA
 Tutti gli armadi sono dotati di ripiani interni con tubi appendiabiti e cassettera.
 Una serie di accessori e attrezzature interne per organizzare al meglio lo spazio degli armadi,
 per organizzare il guardaroba in maniera funzionale.

COMPLETE INTERNAL EQUIPMENT
 All wardrobes are equipped with internal shelves with clothes rail and chest of drawers.
 A series of accessories and internal equipment to better organize the space of the wardrobes,
 to organize the wardrobe in a functional way.





COLLECTION NATURALCHIC

articolo EC-040
letto 1 piazza e mezza con testata legno.
single/double bed with wooden headboard.
cm. l. 134 p. 215 h. 22/60

articolo EC-031B
armadio 2 ante scorrevoli+KIT PANNELLI LEGNO.
wardrobe 2 sliding doors+WOODEN PANEL KIT.
cm. l. 230 p. 65 h. 250

articolo EC-036
comodino con 2 cassetti.
2 drawers bedside table.
cm. l. 80 p. 45 h. 45

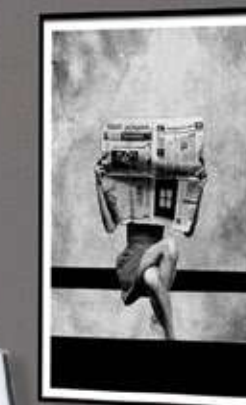



COLLECTION NATURAL CHIC

RICERCA ESTETICA E USO DI MATERIALI PREGIATI.
AESTHETIC RESEARCH AND USE OF VALUABLE MATERIALS.

Nasce dalla creatività, dall'innovazione e dall'esperienza l'armadio il cui tratto qualificante, immediatamente percepibile, si manifesta nell'impiego di materiali di pregio, nell'accuratezza delle lavorazioni e nell'attenzione estrema per ogni singolo dettaglio.

It was born from creativity, innovation and from experience the wardrobe whose qualifying feature, immediately perceptible, it manifests itself in the use of quality materials, in the accuracy of the workmanship and in the extreme attention to every single detail.



articolo EC-030
armadio 5 ante battenti legno.
wardrobe with 5 wooden hinged doors.
cm. l. 280 p. 65 h. 250

articolo EC-030V
armadio 5 ante battenti parte
con centrale a giorno. wardrobe 5 hinged
doors with central compartments.
cm. l. 280 p. 65 h. 250



NATURAL CHIC COLLEZIONE



COLLECTION
NATURALCHIC



articolo **EC-030V**
armadio 5 ante battenti parte
con centrale a giorno. wardrobe 5 hinged
doors with central compartments.
cm. l. 280 p. 65 h. 250

articolo **EC-037**
comodino con 2 cassetti.
2 drawers bedside table.
cm. l. 45 p. 45 h. 45

articolo **EC-039**
letto singolo con testata legno.
single bed with wooden headboard.
cm. l. 104 p. 215 h. 22/60

articolo **EC-065**
cassettiera con 7 cassetti.
drawer dresser with 7 drawers.
cm. l. 80 p. 45 h. 130

COLLECTION

NATURALCHIC

NATURAL CHIC LA ZONA NOTTE CHE VIVI
ANCHE LA MATTINA DOPO NATURAL CHIC THE NIGHT
AREA YOU LIVE EVEN THE MORNING AFTER

articolo EC-032
cornice rettangolare specchio liscio.
rectangular frame smooth mirror.
cm. l. 90 h. 200

articolo EC-066
cassettiera con 5 cassetti.
drawer dresser with 5 drawers.
cm. l. 80 p. 45 h. 99



articolo EC-033
cornice rettangolare specchio liscio.
rectangular frame smooth mirror.
cm. l. 120 h. 85

articolo EC-034
comò doppio con 6 cassetti.
4 drawers double chest of drawers.
cm. l. 160 p. 50 h. 77



articolo EC-037
comodino con 2 cassetti.
2 drawers bedside table.
cm. l. 45 p. 45 h. 45

COLLECTION
NATURALCHIC

articolo EC-027
letto matrimoniale con testata imbottita.
double bed with upholstered headboard.
cm. l. 186 p. 215 h. 22/80

articolo EC-037
comodino con 2 cassetti.
2 drawers bedside table.
cm. l. 45 p. 45 h. 45

articolo EC-038
comodino con vano a giorno.
open compartment bedside table.
cm. l. 80 p. 45 h. 45

articolo EC-065
cassettiera con 7 cassetti.
drawer dresser with 7 drawers.
cm. l. 80 p. 45 h. 130





COLLECTION
NATURALCHIC

articolo EC-031
armadio 2 ante scorrevoli a vetro.
wardrobe with 2 glass sliding doors.
cm. l. 280 p. 65 h. 250

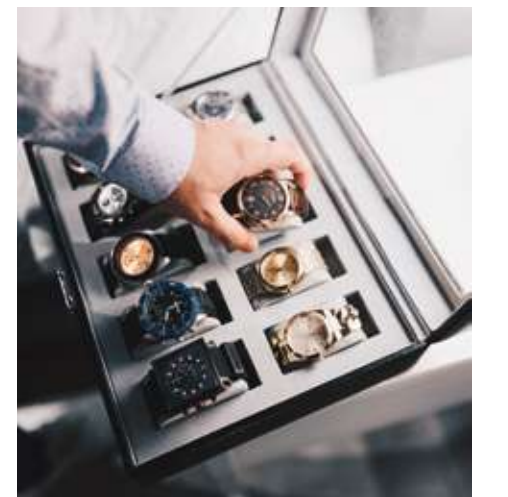

COLLECTION
NATURALCHIC

articolo EC-029
armadio 3 ante scorrevoli legno.
wardrobe with 3 wooden sliding doors.
cm. l. 280 p. 65 h. 250



ATTREZZATURA INTERNA COMPLETA

Tutti gli armadi sono dotati di ripiani interni con tubi appendiabiti e cassettera.
Una serie di accessori e attrezzature interne per organizzare al meglio lo spazio degli armadi,
per organizzare il guardaroba in maniera funzionale.

COMPLETE INTERNAL EQUIPMENT

All wardrobes are equipped with internal shelves with clothes rail and chest of drawers.
A series of accessories and internal equipment to better organize the space of the wardrobes,
to organize the wardrobe in a functional way.



articolo **EC-029**
armadio 3 ante scorrevoli legno.
wardrobe with 3 wooden sliding doors.
cm. l. 280 p. 65 h. 250

articolo **EC-033**
cornice rettangolare specchio liscio.
rectangular frame smooth mirror.
cm. l. 120 h. 85

articolo **EC-035**
comò con 4 cassetti.
4 drawers chest of drawers.
cm. l. 120 p. 50 h. 95

articolo **EC-038**
comodino con vano a giorno.
open compartment bedside table.
cm. l. 80 p. 45 h. 45

articolo **EC-026**
letto matrimoniale con testata legno.
double bed with wooden headboard.
cm. l. 186 p. 215 h. 22/80





COLLECTION
NATURAL CHIC

articolo EC-030
armadio 5 ante battenti legno.
wardrobe with 5 wooden hinged doors.
cm. l. 280 p. 65 h. 250

articolo EC-032
cornice rettangolare specchio liscio.
rectangular frame smooth mirror.
cm. l. 90 h. 200

articolo EC-037
comodino con 2 cassetti.
2 drawers bedside table.
cm. l. 45 p. 45 h. 45

articolo EC-039
letto singolo con testata legno.
single bed with wooden headboard.
cm. l. 104 p. 215 h. 22/60

articolo EC-040
letto 1 piazza e mezza con testata legno.
single/double bed with wooden headboard.
cm. l. 134 p. 215 h. 22/60



ZONA GIORNO LIVING ROOM

SISTEMA componibile ELEMENTI SINGOLI PER composizioni
MODULAR SYSTEM OF SINGLE ELEMENTS FOR COMPOSITIONS

CREDENZE SIDEBOARD



articolo EC-001
credenza 2 porte 1 cestone 2 cassetti.
2 doors sideboard 1 big drawer 2 drawers.
cm. l. 248 p. 45 h. 95



articolo EC-002
credenza con 2 porte.
sideboard with 2 doors.
cm. l. 168 p. 45 h. 95



articolo EC-070
credenza 2 porte 2 cassetti.
2 doors sideboard 2 drawers.
cm. l. 160 p. 45 h. 104

DISPENSE PANTRIES



articolo EC-005
dispensa 2 porte legno 2 porte vetro.
2 wooden doors pantrie 2 glass doors.
cm. l. 168 p. 45 h. 175



articolo EC-006
dispensa 4 porte legno.
4 wooden doors pantrie.
cm. l. 168 p. 45 h. 175



articolo EC-057
dispensa 1 porta legno 1 porta vetro destra.
1 right wooden door pantrie 1 glass door.
cm. l. 88 p. 45 h. 175



articolo EC-058
dispensa 1 porta legno 1 porta vetro sinistra.
1 leaf wooden door pantrie 1 glass door.
cm. l. 88 p. 45 h. 175

VETRINE/LIBRERIE SHOWCASES/ BOOKCASES



articolo EC-004
libreria con ripiani in cristallo.
bookcase with crystal shelves.
cm. l. 110 p. 36 h. 202



articolo EC-054
vetrina 2 porte ripiani in cristallo.
2 doors showcase crystal shelves.
cm. l. 128 p. 36 h. 202



articolo EC-055
vetrina 1 porta destra ripiani in cristallo.
1 right door showcase crystal shelves.
cm. l. 72 p. 36 h. 202



articolo EC-056
vetrina 1 porta sinistra ripiani in cristallo.
1 leaf door showcase crystal shelves.
cm. l. 72 p. 36 h. 202

TAVOLE E SEDIE TABLES AND CHAIRS



art. EC-007 tavolo rettangolare fisso.
rectangular fixed table. cm. l. 220 p. 95 h. 80
art. EC-007/B tavolo rettangolare fisso.
rectangular fixed table. cm. l. 160 p. 95 h. 80
art. EC-007/C tavolo rettangolare fisso.
rectangular fixed table. cm. l. 120 p. 95 h. 80

articolo EC-007/D
tavolo rettangolare con 2 allunghe da cm. 40.
rectangular table with 2 extensions of cm. 40.
cm. l. 120/200 p. 95 h. 80



articolo EC-008
sedia con fondino legno.
chair with wooden seat.
cm. l. 51 p. 51 h. 83 h.s. 45



articolo EC-052
sedia con fondino legno.
chair with wooden seat.
cm. l. 51 p. 51 h. 83 h.s. 45



articolo LF200
sedia in frassino fondino imbottito.
ash wood chair upholstered seat.
cm. l. 68 p. 48 h. 78 h.s. 46

PENSILI HANGERS



articolo EC-009
pensile 2 porte e vani a giorno.
2 doors hanging and compartements.
cm. l. 248 p. 33 h. 68



articolo EC-010
pensile 2 porte e vani a giorno.
2 doors hanging and compartements.
cm. l. 180 p. 33 h. 68



articolo EC-011
pensile 4 porte. 4 doors hanging.
cm. l. 128 p. 33 h. 128



articolo EC-012
pensile 4 porte. 4 doors hanging.
cm. l. 128 p. 33 h. 68



articolo EC-013
pensile a giorno con ripiani.
compartements hanging with shelves.
cm. l. 100 p. 22 h. 100



articolo EC-014
pensile a giorno con ripiani.
compartements hanging with shelves.
cm. l. 50 p. 22 h. 100



articolo EC-060
pensile 1 porta vetro destra.
1 right glass door hanging.
cm. l. 68 p. 33 h. 68



articolo EC-061
pensile 1 porta vetro sinistra.
1 leaf glass door hanging.
cm. l. 68 p. 33 h. 68

MENSOLE SHELVES



articolo EC-015
mensola. cm. l. 100 p. 223 sp. 3



articolo EC-016
mensola. cm. l. 160 p. 223 sp. 3



articolo EC-017
mensola. cm. l. 200 p. 223 sp. 3

BASI BASES



articolo EC-018
base 2 cestoni 2 cassetti.
2 big drawers base 2 drawers.
cm. l. 248 p. 60 h. 59



articolo EC-019
base con vano a giorno.
base with compartement.
cm. l. 200 p. 60 h. 41



articolo EC-020
base 2 cestoni. 2 big drawers base.
cm. l. 168 p. 60 h. 59



articolo EC-021
base 2 cassetti. 2 drawers base.
cm. l. 160 p. 60 h. 41



articolo EC-022
base con vano a giorno.
base with compartement.
cm. l. 160 p. 60 h. 41



articolo EC-050
base 2 cassetti e vano.
2 drawers base and compartement.
cm. l. 148 p. 45 h. 59



articolo EC-051
base 2 cestoni 1 cassetto e vano.
2 big drawers base 1 drawer compartement.
cm. l. 248 p. 45 h. 59

ZONA NOTTE BEDROOM

CASSETTIERE DRAWERS DRESSER



articolo **EC-065**
cassettiera con 7 cassetti.
drawer dresser with 7 drawers.
cm. l. 80 p. 45 h. 130



articolo **EC-066**
cassettiera con 5 cassetti.
drawer dresser with 5 drawers.
cm. l. 80 p. 45 h. 99

LETTI BED



articolo **EC-039**
letto singolo con testata legno.
single bed with wooden headboard.
cm. l. 104 p. 215 h. 22/60



articolo **EC-040**
letto 1 piazza e mezza con testata legno.
single/double bed with wooden headboard.
cm. l. 134 p. 215 h. 22/60



articolo **EC-026**
letto matrimoniale con testata legno.
double bed with wooden headboard.
cm. l. 186 p. 215 h. 22/80



articolo **EC-027**
letto matrimoniale con testata imbottita.
double bed with upholstered headboard.
cm. l. 186 p. 215 h. 22/80



articolo **EC-028**
letto matrimoniale senza testata.
double bed with no headboard.
cm. l. 186 p. 215 h. 22

SISTEMA COMPONIBILE ELEMENTI SINGOLI PER COMPOSIZIONI
MODULAR SYSTEM OF SINGLE ELEMENTS FOR COMPOSITIONS

TAVOLINI SMALL TABLES



articolo **EC-024**
tavolino quadrato con ripiano.
square coffee table with shelf.
cm. l. 90 p. 90 h. 45



articolo **EC-025**
tavolino quadrato con ripiano.
square coffee table with shelf.
cm. l. 45 p. 45 h. 100



articolo **EC-033**
cornice rettangolare specchio liscio.
rectangular frame smooth mirror.
cm. l. 85 h. 120



articolo **EC-032**
cornice rettangolare specchio liscio.
rectangular frame smooth mirror.
cm. l. 90 h. 200

ARMADI WARDROBES



articolo **EC-029**
armadio 3 ante scorrevoli legno.
wardrobe with 3 wooden sliding doors.
cm. l. 280 p. 65 h. 250



articolo **EC-030**
armadio 5 ante battenti legno.
wardrobe with 5 wooden hinged doors.
cm. l. 280 p. 65 h. 250



articolo **EC-031V**
armadio 5 ante battenti parte centrale a giorno.
wardrobe with 5 hinged doors central compartments.
cm. l. 280 p. 65 h. 250



articolo **EC-031**
armadio 2 ante scorrevoli con vetro.
wardrobe with 2 glass sliding doors.
cm. l. 280 p. 65 h. 250



articolo **EC-031B**
armadio 2 ante scorrevoli legno.
wardrobe with 2 wooden sliding doors.
cm. l. 230 p. 65 h. 250

COMÒ, COMODINI E SPECCHIERE CHEST OF DRAWERS,
BEDSIDE TABLES AND MIRRORS



articolo **EC-034**
comò doppio con 6 cassetti.
4 drawers double chest of drawers.
cm. l. 160 p. 50 h. 77



articolo **EC-035**
comò con 4 cassetti.
4 drawers chest of drawers.
cm. l. 120 p. 50 h. 95



articolo **EC-036**
comodino con 2 cassetti.
2 drawers bedside table.
cm. l. 80 p. 45 h. 45



articolo **EC-037**
comodino con 2 cassetti.
2 drawers bedside table.
cm. l. 45 p. 45 h. 45



articolo **EC-038**
comodino con vano a giorno.
open compartment bedside table.
cm. l. 80 p. 45 h. 45

COLLECTIONS DIAMANTE



COLLECTIONS DIAMANTE

SOGGIORNO LUOGO DELL'ACCOGLIENZA E DEL RELAX
LIVING ROOM PLACE OF RECEPTION AND RELAXATION

LA ZONA GIORNO IL LUOGO DELL'ACCOGLIENZA E DEL RELAX. Proponiamo mobili e soluzioni componibili per il soggiorno in diverse essenze e colori, capaci di arredare ogni spazio con attenzione alle tendenze più attuali e alle diverse esigenze di spazio. Potrai così scegliere e creare il tuo Soggiorno Componibile sfruttando tutto lo spazio messo a disposizione, così da poter ricavare nuove soluzioni ed idee senza dover rinunciare alla bellezza ed alla funzionalità dell'arredo. Nella scelta del Soggiorno Componibile, potrai valutare diversi stili, da quello classico a quello moderno, di diverse colorazioni e materiali.

LIVING AREA THE PLACE OF WELCOME AND RELAXATION. We offer modular furniture and solutions for the living room in different essences and colors, capable of furnishing any space with attention to the most current trends and different space requirements. You will thus be able to choose and create your Modular Living Room using all the space made available, so as to be able to obtain new solutions and ideas without having to give up the beauty and functionality of the furniture. In choosing the Modular Living Room, you can evaluate different styles, from classic to modern, of different colors and materials.



COLLECTION DIAMANTE

progetto DIAMANTE 22
parete componibile a moduli.
modular living room. cm. l. 315 p. 35/45/60

PERFETTAMENTE IN LINEA
CON LA TENDENZA ATTUALE LINEE
MORBIDE E LUMINOSE REALIZZATE IN
LACCATO BIANCO E AVORIO.

PERFECTLY IN LINE WITH THE CURRENT
TREND SOFT AND BRIGHT LINES MADE
IN WHITE AND IVORY LACQUERED.

DIAMANTE COLLECTION



RENDERE UNO SPAZIO AL DI FUORI DELLE TENDENZE COMUNI,
SAPER STUPIRE CON ELEMENTI SEMPLICI MA AL CONTEMPO
RAFFINATI IN OGNI SUA FORMA.

MAKE A SPACE OUTSIDE THE TRENDS COMMON, KNOWING
HOW TO AMAZE WITH SIMPLE ELEMENTS BUT AT
THE SAME TIME REFINED IN ALL ITS FORMS.

progetto DIAMANTE 15 parete componibile a moduli.
modular living room. cm. l. 370 p. 30/35/60



COLLECTION DIAMANTE

progetto DIAMANTE 23
parete componibile a moduli.
modular living room. cm. l. 250 p. 35/60





COLLECTION
DIAMANTE

SOLUZIONI DI ARREDO MODULARI
PER OGNI AMBIENTE, SEMPRE IN
LINEA CON LE TUE ESIGENZE.

MODULAR FURNISHING SOLUTIONS
FOR ANY ENVIRONMENT, ALWAYS
IN LINE WITH YOUR NEEDS.

progetto **DIAMANTE 01B**
parete componibile a moduli.
modular living room. cm. l. 370 p. 35/45/60



COLLECTION DIAMANTE

progetto DIAMANTE 27
parete componibile a moduli.
modular living room. cm. l. 310 p. 30/35/60



progetto DIAMANTE 25B
parete componibile a moduli.
modular living room. cm. l. 250 p. 30/35/45/60





COLLECTION
DIAMANTE

progetto DIAMANTE 26
parete componibile a moduli.
modular living room. cm. l. 250 p. 30/45/60

LOVE



DIAMANTE COLLECTION

COLLECTION
DIAMANTE

progetto DIAMANTE 28
parete componibile a moduli.
modular living room. cm. l. 185 p. 30/35/60



progetto DIAMANTE 29
parete componibile a moduli.
modular living room. cm. l. 185 p. 30/35/60



progetto DIAMANTE 19B
parete componibile a moduli.
modular living room. cm. l. 245 p. 30/35/60





COLLECTION DIAMANTE

articolo AD110
base/credenza 3 porte 3 cassetti.
3 doors base/sideboard 3 drawers.
cm. l. 185 p. 45 h. 90



articolo AD109
base/credenza 2 porte 2 cassetti.
2 doors base/sideboard 2 drawers.
cm. l. 125 p. 45 h. 90



progetto DIAMANTE 30
parete componibile a moduli.
modular living room. cm. l. 245 p. 35/60

COLLECTION
DIAMANTE





COLLECTION DIAMANTE

progetto DIAMANTE 04
parete componibile a moduli.
modular living room.
cm. l. 310 p. 35/45/60



progetto DIAMANTE 10B
parete componibile a moduli.
modular living room. cm. l. 245 p. 35/60

DEDICATO A CHI AMA LASCIARSI CONQUISTARE.
UNO STILE COSTRUITO PEZZO PER PEZZO, CON GRANDE ATTENZIONE AI DETTAGLI
E ALLE FINITURE, SEMPRE CONTRASSEGNA TO DALLA PASSIONE E DALLA CONOSCENZA
DEL LEGNO NELLE SUE TANTE ESSENZE.
DEDICATED TO THOSE WHO LIKE TO BE CONQUERED. A STYLE BUILT PIECE BY PIECE,
WITH GREAT ATTENTION TO DETAILS AND FINISHES, ALWAYS MARKED BY THE PASSION
AND KNOWLEDGE OF WOOD IN ITS MANY ESSENCES.



COLLECTION
DIAMANTE

COLLECTION
DIAMANTE

progetto DIAMANTE 31
parete componibile a moduli.
modular living room. cm. l. 245 p. 30/35/60





progetto DIAMANTE 32
parete componibile a moduli.
modular living room. cm. l. 245 p. 22/30/45

COLLECTION
DIAMANTE

168



HOMEVENTUNOCOLLECTIONS

HOMEVENTUNOCOLLECTIONS

169

DIAMANTE COLLECTION



progetto DIAMANTE 18
parete componibile a moduli.
modular living room. cm. l. 245 p. 30/35/60



PIANE PLANS



articolo **AD145**
piana da cm. 125. plan cm. 125.
cm. l. 65 p. 35 h. 11



articolo **AD101**
piana da cm. 125. plan cm. 125.
cm. l. 125 p. 60 h. 11

BASI/CREDENZE BASES/SIDEBOARD



articolo **AD104**
base 2 cestoni. 2 big drawers base.
cm. l. 125 p. 60 h. 40



articolo **AD107**
base 2 porte. 2 doors base.
cm. l. 125 p. 45 h. 48



articolo **AD109**
base/credenza 2 porte 2 cassetti.
2 doors base/sideboard 2 drawers.
cm. l. 125 p. 45 h. 90

TAVOLINI COFFEE TABLES



articolo **AD137**
tavolino con cassetto piano legno.
drawer coffee table with glass top.
cm. l. 125 p. 80 h. 30



SISTEMA componibile ELEMENTI SINGOLI PER composizioni
MODULAR SYSTEM OF SINGLE ELEMENTS FOR COMPOSITIONS



articolo **AD102**
piana da cm. 125. plan cm. 125.
cm. l. 185 p. 60 h. 11



articolo **AD105**
base 3 cestoni. 3 big drawers base.
cm. l. 185 p. 60 h. 40



articolo **AD108**
base 3 porte. 3 doors base.
cm. l. 185 p. 45 h. 48



articolo **AD110**
base/credenza 3 porte 3 cassetti.
3 doors base/sideboard 3 drawers.
cm. l. 185 p. 45 h. 90



articolo **AD138**
tavolino con piano vetro.
coffee table with glass top.
cm. l. 80 p. 80 h. 30



articolo **AD103**
piana da cm. 125. plan cm. 125.
cm. l. 245 p. 60 h. 11



articolo **AD106**
base 4 cestoni. 4 big drawers base.
cm. l. 245 p. 60 h. 40



articolo **AD113**
base con ripiano. base with shelf.
cm. l. 125 p. 45 h. 95



articolo **AD111**
base/credenza 4 porte 4 cassetti.
4 doors base/sideboard 4 drawers.
cm. l. 245 p. 45 h. 90



articolo **AD114**
base con ripiano. base with shelf.
cm. l. 125 p. 45 h. 55

PENSILI HANGERS



articolo **AD118**
pensile 4 porte battenti vetro.
4 glass hinged doors hanging.
cm. l. 125 p. 35 h. 125



articolo **AD119**
pensile a giorno con ripiani.
compartement hanging with shelves.
cm. l. 125 p. 35 h. 125



articolo **AD120**
pensile 1 porta battente vetro.
1 glass hinged door hanging.
cm. l. 37 p. 35 h. 125



articolo **AD120B**
pensile 1 porta battente vetro.
1 glass hinged door hanging.
cm. l. 37 p. 35 h. 125



articolo **AD121**
pensile a giorno con ripiani.
comp.hanging with shelves.
cm. l. 37 p. 35 h. 125



articolo **AD122**
pensile 1 porta battente legno.
1 wood hinged door hanging.
cm. l. 37 p. 35 h. 125



articolo **AD123B**
pensile 1 porta battente vetro.
1 glass hinged door hanging.
cm. l. 65 p. 35 h. 65



articolo **AD123**
pensile 1 porta battente vetro.
1 glass hinged door hanging.
cm. l. 65 p. 35 h. 65



articolo **AD124**
pensile a giorno con ripiano.
compartement hanging with shelf.
cm. l. 65 p. 35 h. 65



articolo **AD125**
pensile 1 porta battente legno.
1 wood hinged door hanging.
cm. l. 65 p. 35 h. 65



articolo **MB152**
pensile a giorno.
compartement hanging.
cm. l. 40 p. 17 h. 40



articolo **AD126B**
pensile 1 porta vasistas vetro.
1 glass vasistas door hanging.
cm. l. 125 p. 35 h. 37



articolo **AD126**
pensile 1 porta vasistas vetro.
1 glass vasistas door hanging.
cm. l. 125 p. 35 h. 37



articolo **AD127**
pensile a giorno con tramezzo.
compartement hanging with partition.
cm. l. 125 p. 35 h. 37



articolo **AD140**
pensile 1 porta vasistas vetro.
1 glass vasistas door hanging.
cm. l. 65 p. 35 h. 37

MENSOLE SHELVES



articolo **AD131**
mensola da cm. 125. shelf cm. 125.
cm. l. 125 p. 30 h. 4



articolo **AD132**
mensola da cm. 185. shelf cm. 185.
cm. l. 185 p. 30 h. 4



articolo **AD155**
mensola da cm. 42. shelf cm. 42.
cm. l. 42 p. 30 h. 4



articolo **AD133**
mensola da cm. 245. shelf cm. 245.
cm. l. 245 p. 30 h. 4



articolo **AD134**
mensola al cm. shelf to cm.



articolo **AD156**
mensola da cm. 62,5. shelf cm. 62,5.
cm. l. 62,5 p. 30 h. 4



articolo **AD158**
mensola con tacca. shelf with notch.
cm. l. 100 p. 22 h. 3



articolo **AD142**
mensola a V cm. 142. V shelf cm. 142.
cm. l. 142 p. 30



articolo **AD143**
mensola a V cm. 210. V shelf cm. 210.
cm. l. 210 p. 30



articolo **AD157**
mensola da cm. 62,5. shelf cm. 62,5.
cm. l. 85,5 p. 30 h. 4



articolo **AD159**
mensola con tacca. shelf with notch.
cm. l. 160 p. 22 h. 3

COLLECTIONS CHARME



COLLECTIONS CHARME

UN'ABITAZIONE RICAVATA DA UN AMBIENTE UNICO
A HOUSE MADE FROM A UNIQUE ENVIRONMENT



ARREDARE CON LA PROFESSIONALITÀ DEL DESIGN MODERNO CHE SI INTEGRA FRA FUNZIONALITÀ E GUSTO ESTETICO. Elementi d'arredo protagonisti di casa che vi aiutano a trascorrere ogni momento della vostra vita quotidiana da passare in famiglia o con un'allegria compagnia di amici. Articoli per ogni uso come la sala pranzo arredata da una vasta gamma di tavoli con struttura in cristallo, cristallo e legno, totalmente in legno o soluzioni abbinata a gambe in metallo, tutti accompagnati da una numerosa proposta di sedie di ogni tipologia da quella totalmente in legno fino a quelle imbottite. La zona soggiorno è il locale più vissuto della casa impreziosito da vetrine con o senza cassetti abbinata a credenze con ante battenti, ante e cassetti, ante scorrevoli e porta TV il tutto realizzato in diverse finiture e materiali per tutti i gusti in modo da personalizzare la vostra casa. Completano l'ampia collezione le librerie a muro o da centro stanza per suddividere un ampio locale o da protagonista in un loft e consolle abbinata ad attaccapanni e specchiere di estrema semplicità ma con una straordinaria personalità. Comodissimi i tavolini d'appoggio da collocare di fronte ai divani o a fianco a seconda delle esigenze.

FURNISH WITH THE PROFESSIONALISM OF MODERN DESIGN THAT INTEGRATES BETWEEN FUNCTIONALITY AND AESTHETIC TASTE. Furnishing elements protagonists of the home that help you to spend every moment of your daily life to spend with your family or with a cheerful company of friends. Items for every use such as the dining room furnished with a wide range of tables with crystal, crystal and wood structure, totally in wood or solutions combined with metal legs, all accompanied by a numerous proposal of chairs of all types from that totally in wood up to the padded ones. The living area is the most lived-in room in the house embellished with showcases with or without drawers combined with sideboards with hinged doors, doors and drawers, sliding doors and TV stands, all made in different finishes and materials for all tastes in order to personalize your home. The large collection is completed by wall-mounted or freestanding bookcases to divide a large room or as a protagonist in a loft and console combined with extremely simple cabinets and mirrors but with an extraordinary personality. The side tables are very comfortable to be placed in front of the sofas or next to them depending on your needs.



articolo 710/G
vetrina sagomata 2 porte vetro.
shaped 2 glass doors showcase.
cm. l. 170 p. 50 h. 215

articolo 700/G
credenza sagomata 2 porte.
2 doors shaped sideboard.
cm. l. 200 p. 58 h. 98

COLLECTION CHARME





articolo 716/G
vetrina sagomata 2 porte vetro.
shaped 2 glass doors showcase.
cm. l. 130 p. 50 h. 200

articolo FR032
sedia con fondino e schienale imbottiti.
chair with upholstered seat and back.
cm. l. 56 p. 46 h. 118 hs. 51

articolo 703/G
tavolo ovale allungabile con 1 allunga.
extendable oval table with 1 extension.
cm. l. 160 p. 90 h. 80 aperto. open. 200 x 90

COLLECTION CHARME



articolo FR035
sedia imbottita. upholstered chair.
cm. l. 56 p. 46 h. 118 h.s. 51



articolo 375/G
sedia con fondino imbottito.
chair with upholstered seat.
cm. l. 46 p. 45 h. 91,5 hs. 45,5



COLLECTION CHARME

articolo 715/G
vetrina sagomata 2 porte vetro.
shaped 2 glass doors showcase.
cm. l. 130 p. 50 h. 200

articolo 708/G
credenza sagomata 2 porte.
2 doors shaped sideboard.
cm. l. 110 p. 53 h. 89

articolo 705/G
tavolino rotondo piano in cristallo.
round glass top coffee table.
cm. ø. 100 p. 42





articolo 714/G
comò sagomato 8 cassetti.
8 drawers shaped chest of drawers.
cm. l. 185 p. 56 h. 95

COLLECTION
CHARME



COLLECTION CHARME

articolo 709/G
credenza sagomata 2 porte 3 cassetti.
2 doors shaped sideboard 3 drawers.
cm. l. 210 p. 60 h. 100

articolo 702/G
vetrina sagomata 1 porta vetro.
shaped 1 glass door showcase.
cm. l. 78 p. 49 h. 200





articolo 716/G
vetrina sagomata 2 porte vetro.
shaped 2 glass doors showcase.
cm. l. 130 p. 50 h. 200

articolo FR035
sedia con fondino e schienale imbottiti.
chair with upholstered seat and back.
cm. l. 56 p. 46 h. 118 hs. 51

articolo 703/G
tavolo ovale allungabile con 1 allunga.
extendable oval table with 1 extension.
cm. l. 160 p. 90 h. 80 aperto. open. 200 x 90

articolo 711/G
credenza sagomata 2 porte.
2 doors shaped sideboard.
cm. l. 150 p. 60 h. 90



UNO SPAZIO APERTO DOVE LE IDEE VOLANO
E I PROGETTI PRENDONO VITA, CON LA POSSIBILITÀ
ANCHE DI UN BREAK RILASSANTE.

AN OPEN SPACE WHERE IDEAS FLY
AND PROJECTS COME TO LIFE, WITH THE
POSSIBILITY OF A RELAXING BREAK.



COLLECTION CHARME



articolo 702/G
vetrina sagomata 1 porta vetro.
shaped 1 glass door showcase.
cm. l. 78 p. 49 h. 200

articolo 733/G
base sagomata porta TV 2 porte 3 cassetti.
2 doors shaped base TV stand 3 drawers.
cm. l. 166 p. 44 h. 68



CHARME COLLECTION



LE VETRINETTE PER SOGGIORNO SONO UN ELEMENTO IMPRESCINDIBILE NELLE NOSTRE CASE, RENDONO PIÙ LUMINOSA LA NOSTRA STANZA GRAZIE ALLA LORO TRASPARENZA.
LIVING SHOWCASES ARE AN ESSENTIAL ELEMENT IN OUR HOUSES, THEY MAKE OUR ROOM BRIGHT THANKS TO THEIR TRANSPARENCY.

articolo 712/G
vetrinetta sagomata 1 porta vetro.
shaped 1 glass door showcase.
cm. l. 70 p. 47 h. 102



COLLECTION
CHARME

articolo 713/G
vetrinetta sagomata 2 porte vetro.
shaped 2 glass doors showcase.
cm. l. 107 p. 46 h. 102





articolo 709/G
credenza sagomata 2 porte 3 cassetti.
2 doors shaped sideboard 3 drawers.
cm. l. 210 p. 60 h. 100

articolo 702/G
vetrina sagomata 1 porta vetro.
shaped 1 glass door showcase.
cm. l. 78 p. 49 h. 200



articolo M30CL cm. ø. 35

articolo M31CL cm. ø. 45
pomello con swarovski. knob with swarovski.



articolo M34CL cm. ø. 35

articolo M35CL cm. ø. 60
maniglia cromo lucido. polished chrome handle.



CHARME COLLECTION

COLLECTION
CHARME



articolo M32BO cm. ø. 45

articolo M33BO cm. ø. 60
pomello con swarovski. knob with swarovski.



articolo M34BO cm. ø. 35

articolo M35BO cm. ø. 60
maniglia bagno oro. gold-plated handle.

HOMEVENTUNOCOLLECTIONS



articolo 1711/G
credenza sagomata 2 porte con rilievi.
2 doors shaped sideboard with reliefs.
cm. l. 150 p. 50 h. 90

articolo 1715/G
vetrina sagomata 2 porte con cimasa.
2 doors shaped display cabinet with crown.
cm. l. 130 p. 50 h. 212

articolo 1752/G
tavolo rettangolare fisso.
rectangular fixed table.
cm. l. 160 p. 90 h. 80

articolo 1753/G
tavolo rettangolare allungabile 1 all 45 cm.
extendable rectangular table 1 ext. 45 cm.
cm. l. 160 p. 90 h. 80
aperto. open. 205 x 90

articolo FR032
sedia imbottita. upholstered chair.
cm. l. 52 p. 46 h. 110 h.s. 51



COLLECTION
CHARME

articolo 1711/G
credenza sagomata 2 porte con rilievi.
2 doors shaped sideboard with reliefs.
cm. l. 150 p. 50 h. 90

articolo 1715/G
vetrina sagomata 2 porte con cimasa.
2 doors shaped display cabinet with crown.
cm. l. 130 p. 50 h. 212

articolo 1752/G
tavolo rettangolare fisso.
rectangular fixed table.
cm. l. 160 p. 90 h. 80

articolo 1753/G
tavolo rettangolare allungabile 1 all 45 cm.
extendable rectangular table 1 ext. 45 cm.
cm. l. 160 p. 90 h. 80
aperto. open. 205 x 90

articolo FR032
sedia imbottita. upholstered chair.
cm. l. 52 p. 46 h. 110 h.s. 51



COLLECTION
CHARME

articolo 722/G
cassettiera sagomata 7 cassetti.
shaped 7 drawers dresser.
cm. l. 85 p. 50 h. 140



articolo 719/G
cassettiera sagomata 5 cassetti.
shaped 5 drawers dresser.
cm. l. 85 p. 50 h. 105



articolo 704/G
cassettiera sagomata 5 cassetti.
shaped 5 drawers dresser.
cm. l. 60 p. 40 h. 100



articolo 1717/G
cassettiera 7 cassetti con rilievo.
7 drawers dresser with relief.
cm. l. 60 p. 40 h. 130



CREA ARREDI DALLO STILE RIGOROSO, CONIUGANO
FORME LA CUI BELLEZZA SI MISURA CON LE ESIGENZE DI PRATICITÀ,
TIPICHE DELLE ABITAZIONI CONTEMPORANEE.

CREATE FURNITURE WITH A RIGOROUS STYLE, COMBINE
SHAPES WHOSE BEAUTY IS MEASURED WITH THE NEEDS OF PRACTICALITY,
TYPICAL OF CONTEMPORARY HOUSES.

COLLECTION
CHARME

articolo 1755/G
tavolino tondo intagliato piano legno.
carved round coffee table wooden top.
cm. ø. 50 h. 60



articolo 1735/GB
tavolino ovale intagliato piano legno.
carved oval coffee table wooden top.
cm. l. 105 p. 60 h. 46



articolo 735/GB
tavolino ovale piano vetro.
oval coffee table glass top.
cm. l. 105 p. 60 h. 46



articolo 1722/G
cassettiera sagomata 7 cassetti con rilievo.
shaped 7 drawers dresser with relief.
cm. l. 85 p. 50 h. 140





COLLECTION CHARME

articolo 1722/G
cassettiera sagomata 7 cassetti con rilievo.
shaped 7 drawers dresser with relief.
cm. l. 85 p. 50 h. 140



articolo 1740/G
cornice ovale traforata specchio liscio.
perforated oval frame smooth mirror.
cm. l. 88 h. 108

articolo 724/G
consolle sagomata 3 cassetti.
shaped 3 drawers console.
cm. l. 90 p. 40 h. 85



articolo 723/G
consolle sagomata 5 cassetti.
shaped 5 drawers console.
cm. l. 120 p. 40 h. 90

articolo 706/G
consolle sagomata mezzaluna.
half-moon shaped console.
cm. l. 115 p. 50 h. 83



articolo 717/G
cassettiera sagomata 7 cassetti.
shaped 7 drawers dresser.
cm. l. 60 p. 40 h. 130



articolo 1724/G
consolle sagomata 3 cassetti.
shaped 3 drawers console.
cm. l. 90 p. 40 h. 85





articolo 1750/G
tavolo quadrato intagliato fisso.
fixed carved square table.
cm. l. 100 p. 100 h. 80

articolo FR032
sedia con fondino e schienale imbottiti.
chair with upholstered seat and back.
cm. l. 52 p. 46 h. 110 h.s. 51



articolo 1708/G
credenza sagomata 2 porte con rilievi.
shaped sideboard 2 doors with reliefs.
cm. l. 110 p. 53 h. 89

articolo FR084
plafoniera da muro. wall ceiling light.
cm. l. 30 p. 15 h. 60

articolo FR082+FR078
piantana piccola+paralume.
small floor lamp + lampshade.
cm. l. 50 h. 62

COLLECTION
CHARME

COLLECTION
CHARME



articolo 1709/G
credenza sagomata 2 porte rilievo 3 cassetti.
shaped sideboard 2 doors relief 3 drawers.
cm. l. 201 p. 60 h. 100

articolo 1739/G
cornice rettangolare dorata.
golden rectangular mirror.
cm. l. 180 sp. 6 h. 85

articolo FR081+FR076
piantana media con paralume.
medium floor lamp with shade.
cm. ø. 34 h. 92

articolo 1754/G
tavolo rettangolare intagliato 1 all. da cm. 45.
carved rectangular table 1 ext. cm. 45.
cm. l. 180/225 p. 90 h. 80

articolo FR032
sedia con fondino e schienale imbottiti.
chair with upholstered seat and back.
cm. l. 56 p. 46 h. 118 hs. 51

articolo FR080+FR075
piantana grande con paralume.
big floor lamp with shade.
cm. ø. 43 h. 200

articolo 1716/G
vetrina sagomata 2 porte vetro con rilievo.
shaped showcase 2 glass doors with relief.
cm. l. 130 p. 50 h. 212





articolo 1702/G
 vetrina sagomata 1 porta con rilievo
 apertura destra o sinistra. shaped showcase
 1 door with relief right or left opening.
 cm. l. 78 p. 49 h. 212

articolo 1733/G
 base 2 porte con rilievi 3 cassetti.
 2 doors base with reliefs 3 drawers.
 cm. l. 166 p. 44 h. 68

articolo 1737/G
 pensile porta TV con rilievi.
 hanging TV stand with reliefs.
 cm. l. 144 p. 30 h. 110

COLLECTION
 CHARME

HOMEVENTUNOCOLLECTIONS





articolo 1717/G
cassettiera sagomata 7 cassetti con rilievo.
shaped 7 drawers dresser with relief.
cm. l. 60 p. 40 h. 130

articolo FR080
piantana grande. big floor lamp.
cm. ø. 43 h. 200

articolo FR068
cornice rotonda traforata specchio liscio.
round perforated frame smooth mirror.
cm. ø. 95 p. 3

articolo 706/G
consolle sagomata mezzaluna.
half-moon shaped console.
cm. l. 115 p. 50 h. 83

COLLECTION
CHARME

HOMEVENTUNOCOLLECTIONS



COLLECTION CHARME



articolo 726/G
letto matrimoniale con pannello traforato.
double bed with perforated panel.
cm. l. 180 p. 205 h. 114

articolo 727/G
comodino sagomato 3 cassetti.
3 drawers shaped bedside table .
cm. l. 62 p. 40 h. 70

articolo 732/G
armadio sagomato 4 ante battenti.
4 hinged doors shaped wardrobe.
cm. l. 260 p. 67 h. 225



CHARME COLLECTION



COLLECTION CHARME

articolo 725/G
comò sagomato 5 cassetti.
3 drawers shaped chest of drawers.
cm. l. 140 p. 57 h. 112

articolo 726/G
letto matrimoniale con pannello traforato.
double bed with perforated panel.
cm. l. 180 p. 205 h. 114

articolo 727/G
comodino sagomato 3 cassetti.
3 drawers shaped bedside table.
cm. l. 62 p. 40 h. 70





articolo **727/G**
comodino sagomato 3 cassetti.
3 drawers shaped bedside table .
cm. l. 62 p. 40 h. 70

articolo **728/G**
letto singolo con pannello legno.
single bed with wooden panel.
cm. l. 95 p. 205 h. 110

articolo **717/G**
cassettiera sagomata 7 cassetti.
7 drawers shaped drawers dresser.
cm. l. 60 p. 40 h. 130



articolo **725/G**
comò sagomato 5 cassetti.
3 drawers shaped chest of drawers.
cm. l. 140 p. 57 h. 112

articolo **726/G**
letto matrimoniale con pannello ecopelle.
double bed with eco-leather panel.
cm. l. 180 p. 205 h. 114

articolo **727/G**
comodino sagomato 3 cassetti.
3 drawers shaped bedside table .
cm. l. 62 p. 40 h. 70



articolo 731/G
 letto a castello con pannelli legno.
 bunk bed with wooden panels.
 cm. l. 100 p. 205 h. 195

articolo 717/G
 cassetiera sagomata 7 cassetti.
 7 drawers shaped drawers dresser.
 cm. l. 60 p. 40 h. 130

articolo 730/G
 armadio sagomato 2 ante battenti.
 2 hinged doors shaped wardrobe.
 cm. l. 145 p. 65 h. 200







articolo 1740/G
cornice ovale traforata.
perforated oval mirror.
cm. l. 108 h. 88

articolo 1725/G
comò 5 cassetti con intaglio.
chest of 5 drawers with carving.
cm. l. 140 p. 57 h. 112

COLLECTION
CHARME



articolo 1760/G
armadio 3 ante scorrevoli con intaglio
e specchio centrale. 3 sliding doors wardrobe
with carving and central mirror.
cm. l. 286 p. 69,5 h. 250

SENZA RILIEVO WITHOUT RELIEF



articolo 700/G
credenza sagomata 2 porte.
cm. l. 200 p. 58 h. 98



articolo 702/G
vetrina sagomata 1 porta DX o SX.
cm. l. 78 p. 49 h. 212



articolo 704/G
cassettiera sagomata 5 cassetti.
cm. l. 60 p. 40 h. 100



articolo 706/G
consolle sagomata mezzaluna.
cm. l. 115 p. 50 h. 83



articolo 708/G
credenza sagomata 2 porte.
cm. l. 110 p. 53 h. 89

SENZA RILIEVO WITHOUT RELIEF



articolo 709/G
credenza sagomata 2 porte 3 cassetti.
cm. l. 201 p. 60 h. 100



articolo 710/G
vetrina sagomata 2 porte vetro.
cm. l. 170 p. 50 h. 215



articolo 711/G
credenza sagomata 2 porte.
cm. l. 150 p. 50 h. 90



articolo 712/G
vetrinetta sagomata 1 porta vetra.
cm. l. 70 p. 47 h. 102



articolo 713/G
vetrinetta sagomata 2 porte vetro.
cm. l. 107 p. 46 h. 102

COLLECTION
CHARME

CON RILIEVO
WITH RELIEF



articolo 1702/G
vetrina sagomata 1 porta DX o SX.
cm. l. 78 p. 49 h. 212



articolo 1704/G
cassettiera sagomata 5 cassetti.
cm. l. 60 p. 40 h. 100



articolo 1706/G
consolle sagomata mezzaluna.
cm. l. 115 p. 50 h. 83



articolo 1708/G
credenza sagomata 2 porte.
cm. l. 110 p. 53 h. 89

CON RILIEVO WITH RELIEF



articolo 1709/G
credenza sagomata 2 porte 3 cassetti.
cm. l. 201 p. 60 h. 100



articolo 1710/G
vetrina sagomata 2 porte vetro.
cm. l. 170 p. 50 h. 215



articolo 1711/G
credenza sagomata 2 porte.
cm. l. 150 p. 50 h. 90



articolo 1712/G
vetrinetta sagomata 1 porta vetra.
cm. l. 70 p. 47 h. 102



articolo 1713/G
vetrinetta sagomata 2 porte vetro.
cm. l. 107 p. 46 h. 102

SENZA RILIEVO WITHOUT RELIEF



articolo 714/G
comò sagomato 8 cassetti.
cm. l. 185 p. 56 h. 95



articolo 715/G
vetrina sagomata 2 porte vetro.
cm. l. 130 p. 50 h. 212



articolo 716/G
vetrina sagomata 2 porte.
cm. l. 130 p. 50 h. 212



articolo 717/G
cassettiera sagomata 7 cassetti.
cm. l. 60 p. 40 h. 130



articolo 719/G
cassettiera sagomata 5 cassetti.
cm. l. 85 p. 50 h. 105

SENZA RILIEVO WITHOUT RELIEF



articolo 722/G
cassettiera sagomata 7 cassetti.
cm. l. 85 p. 50 h. 140



articolo 723/G
consolle sagomata 5 cassetti.
cm. l. 120 p. 40 h. 90



articolo 724/G
consolle sagomata 3 cassetti.
cm. l. 90 p. 40 h. 85



articolo 725/G
comò sagomato 5 cassetti.
cm. l. 140 p. 57 h. 112



articolo 727/G
comodino sagomato 3 cassetti.
cm. l. 62 p. 40 h. 70

CON RILIEVO WITH RELIEF



articolo 1715/G
vetrina sagomata 2 porte vetro.
cm. l. 130 p. 50 h. 212



articolo 1716/G
vetrina sagomata 2 porte.
cm. l. 130 p. 50 h. 212



articolo 1717/G
cassettiera sagomata 7 cassetti.
cm. l. 60 p. 40 h. 130



articolo 1719/G
cassettiera sagomata 5 cassetti.
cm. l. 85 p. 50 h. 105

CON RILIEVO WITH RELIEF



articolo 1722/G
cassettiera sagomata 7 cassetti.
cm. l. 85 p. 50 h. 140



articolo 1723/G
consolle sagomata 5 cassetti.
cm. l. 120 p. 40 h. 90



articolo 1724/G
consolle sagomata 3 cassetti.
cm. l. 90 p. 40 h. 85



articolo 1725/G
comò sagomato 5 cassetti.
cm. l. 140 p. 57 h. 112



articolo 1727/G
comodino sagomato 3 cassetti.
cm. l. 62 p. 40 h. 70

SENZA RILIEVO WITHOUT RELIEF



articolo 703/G
tavolo ovale 1 allunga da cm. 40
cm. l. 160 p. 90 h. 80



articolo 703/GB
tavolo ovale 1 allunga da cm. 40
cm. l. 180 p. 110 h. 80



articolo 718/G
tavolo rotondo 1 allunga da cm. 40
cm. ø. 110 h. 80



articolo 736/G
tavolo rettangolare fisso
cm. l. 180 p. 90 h. 80



articolo 754/G
tavolo rettangolare 1 allunga da cm. 45
cm. l. 180 p. 90 h. 80

SENZA RILIEVO WITHOUT RELIEF



articolo 750/G Tag
tavolo quadrato fisso
cm. l. 100 p. 100 h. 80



articolo 751/G
tavolo quadrato 1 allunga da cm. 40
cm. l. 100 p. 100 h. 80



articolo 752/G
tavolo rettangolare fisso
cm. l. 160 p. 90 h. 80



articolo 753/G
tavolo rettangolare 1 allunga da cm. 45
cm. l. 160 p. 90 h. 80

CON RILIEVO WITH RELIEF



articolo 1703/G
tavolo ovale 1 allunga da cm. 40
cm. l. 160 p. 90 h. 80



articolo 1703/GB
tavolo ovale 1 allunga da cm. 40
cm. l. 180 p. 110 h. 80



articolo 1718/G
tavolo rotondo 1 allunga da cm. 40
cm. ø. 110 h. 80



articolo 1736/G
tavolo rettangolare fisso
cm. l. 180 p. 90 h. 80



articolo 1754/G
tavolo rettangolare 1 allunga da cm. 45
cm. l. 180 p. 90 h. 80

CON RILIEVO WITH RELIEF



articolo 1750/G
tavolo quadrato fisso
cm. l. 100 p. 100 h. 80



articolo 1751/G
tavolo quadrato 1 allunga da cm. 40
cm. l. 100 p. 100 h. 80



articolo 1752/G
tavolo rettangolare fisso
cm. l. 160 p. 90 h. 80



articolo 1753/G
tavolo rettangolare 1 allunga da cm. 45
cm. l. 160 p. 90 h. 80

SENZA RILIEVO WITHOUT RELIEF



articolo 734/G
tavolino ovale piano vetro.
cm. l. 125 p. 70 h. 46



articolo 734/GB
tavolino ovale piano legno.
cm. l. 125 p. 70 h. 46



articolo 735/G
tavolino ovale piano vetro.
cm. l. 105 p. 60 h. 46



articolo 735/GB
tavolino ovale piano legno.
cm. l. 105 p. 60 h. 46



articolo 755/G
tavolino rotondo piano legno.
cm. ø. 50 h. 60

SENZA RILIEVO WITHOUT RELIEF



articolo 730/G
armadio sagomato 2 ante battenti.
cm. l. 145 p. 65 h. 200



articolo 732/G
armadio sagomato 4 ante battenti.
cm. l. 260 p. 67 h. 225



articolo 760/G
armadio 3 ante scorrevoli e specchio.
cm. l. 286 p. 69,5 h. 250

CON RILIEVO WITH RELIEF



articolo 1734/G
tavolino ovale piano legno.
cm. l. 125 p. 70 h. 46



articolo 1734/GB
tavolino ovale piano legno.
cm. l. 125 p. 70 h. 46



articolo 1735/G
tavolino ovale piano legno.
cm. l. 105 p. 60 h. 46



articolo 1735/GB
tavolino ovale piano legno.
cm. l. 105 p. 60 h. 46



articolo 1755/G
tavolino rotondo piano legno.
cm. ø. 50 h. 60

CON RILIEVO WITH RELIEF



articolo 1730/G
armadio sagomato 2 ante battenti.
cm. l. 145 p. 65 h. 200



articolo 1732/G
armadio sagomato 4 ante battenti.
cm. l. 260 p. 67 h. 225



articolo 1760/G
armadio 3 ante scorrevoli e specchio.
cm. l. 286 p. 69,5 h. 250



articolo 1761/G
letto con testata intagliata e imbottita.
cm. l. 204 p. 216 h. 155 rete. cm. 160

SENZA RILIEVO WITHOUT RELIEF



articolo 733/G
base sagomata 2 porte 3 cassetti.
cm. l. 166 p. 44 h. 68



articolo 737/G
pensile porta TV con rilievi.
cm. l. 144 p. 30 h. 110



articolo 1733/G
base sagomata 2 porte 3 cassetti.
cm. l. 166 p. 44 h. 68



articolo 1737/G
pensile porta TV con rilievi.
cm. l. 144 p. 30 h. 110

articolo 1762/G
letto con testata intagliata e imbottita.
cm. l. 224 p. 216 h. 155 rete. cm. 180

COLLECTION
CHARME

SEDIE SPECCHIERE E LUCI
CHAIRS, MIRRORS AND LIGHTS



articolo **FR032**
sedia fondino e schienale imbottiti.
cm. l. 52 p. 46 h. 110 h.s. 51



articolo **FR033**
sedia fondino e schienale imbottiti.
cm. l. 56 p. 46 h. 110 h.s. 51



articolo **375/G**
sedia con fondino imbottito.
cm. l. 46 p. 45 h. 91,5 hs. 45,5



articolo **622/G**
sedia con fondino imbottito.
cm. l. 46 p. 41,5 h. 95,5 h.s. 45,5



articolo **1738/G**
specchiera rettangolare foglia oro.
cm. l. 105 sp. 6 h. 85



articolo **1739/G**
specchiera rettangolare foglia oro.
cm. l. 185 sp. 6 h. 85



articolo **FR065**
cornice quadrata traforata.
cm. l. 98 sp. 3 h. 98



articolo **FR066**
cornice rettangolare traforata.
cm. l. 150 sp. 3 h. 98



articolo **FR067**
cornice rotonda traforata.
cm. ø. 95 sp. 3



articolo **FR080**
piantana grande
cm. h. totale 200



articolo **FR081**
piantana media.
cm. h. totale 92



articolo **FR082**
piantana piccola.
cm. h. totale 84



articolo **FR083**
plafoniera da muro.
cm. l. 30 p. 15 h. 60



articolo **1740/G**
cornice ovale traforata.
cm. l. 108 h. 88



articolo **FR080**
piantana grande
cm. h. totale 178



articolo **FR081**
piantana media.
cm. h. totale 73



articolo **FR082**
piantana piccola.
cm. h. totale 62



articolo **FR084**
plafoniera da muro.
cm. l. 30 p. 15 h. 60

COLLECTION
CHARME

MANIGLIE HANDLES

FINITURE MANIGLIE
CL: CROMO LUCIDO
BO: BAGNO ORO ZECCHINO



articolo **M30CL** cm. ø. 35
articolo **M31CL** cm. ø. 45
pomello con swarovski.
knob with swarovski.



articolo **M32CL** cm. ø. 45
articolo **M33CL** cm. ø. 60
pomello con swarovski.
knob with swarovski.



articolo **M34CL** cm. ø. 35
articolo **M35CL** cm. ø. 60
maniglia cromo lucido.
polished chrome handle.



articolo **M30BO** cm. ø. 35
articolo **M31BO** cm. ø. 45
pomello con swarovski.
knob with swarovski.



articolo **M32BO** cm. ø. 45
articolo **M33BO** cm. ø. 60
pomello con swarovski.
knob with swarovski.



articolo **M34BO** cm. ø. 35
articolo **M35BO** cm. ø. 60
maniglia bagno oro.
gold-plated handle.

VELLUTI TESSUTI E PELLI
VELVETS, FABRICS LEATHER



VELLUTO BLU **G074/520**



VELLUTO BIANCO **G074/500**



VELLUTO NOCCIOLA **G074/506**



VELLUTO PANCHETTA **G076/204**

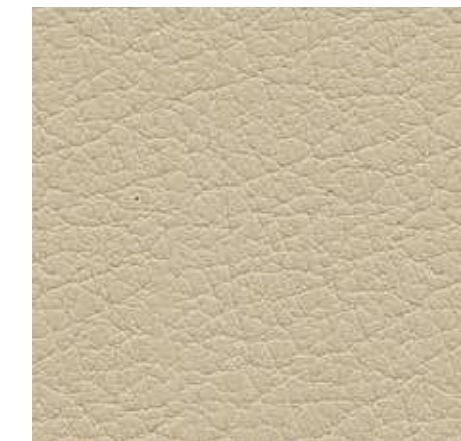

SKY CASTING **11312**



PUNTINO BLU **CLG 067-05**



PUNTINO BIANCO **CLG 067-01**



FIORE BIANCO **CLG 06-01**

COLLECTIONS FRANCESCO



UN'ABITAZIONE RICAVATA DA UN AMBIENTE UNICO, di solito uno spazio industriale o commerciale dismesso di notevole superficie, caratterizzato da quasi totale assenza di divisori e da altezze interne maggiori rispetto agli immobili costruiti ad uso residenziale e maggiori superfici finestrate, con inserimento di dotazioni igienico-sanitarie adatte all'uso di abitazioni particolarmente confortevoli e personalizzate. Si dice loft anche un'abitazione molto ampia che segue lo stesso stile nell'utilizzo e nell'organizzazione aperta degli spazi interni. Lo studio della trasformazione è particolarmente riuscito se eseguito partendo dalla valorizzazione degli elementi preesistenti resi funzionali con il nuovo utilizzo residenziale. Il recupero di spazi industriali dismessi ad uso abitativo presenta anche l'aspetto positivo di evitare il consumo di territorio con nuove costruzioni, sottraendo i manufatti ad una condizione di progressivo degrado con evidente recupero del paesaggio. La parola inglese loft, il cui significato proprio è solaio/soffitto, deriva dal norvegese antico "lopt" ("aria", confrontabile con il tedesco "luft", con il medesimo significato). Le prime esperienze di realizzazione di loft risalgono agli anni '70 del Novecento e traggono origine dall'allestimento di case-atelier da parte di artisti americani nei pressi di New York.

A HOUSE OBTAINED FROM A UNIQUE ENVIRONMENT, usually an abandoned industrial or commercial space of considerable surface, characterized by the almost total absence of partitions and by greater internal heights compared to buildings built for residential use and greater windowed surfaces, with the inclusion of hygienic equipment -sanitary suitable for the use of particularly comfortable and personalized homes. A very large house is also called a loft that follows the same style in the use and open organization of the interior spaces. The transformation study is particularly successful if carried out starting from the enhancement of the pre-existing elements made functional with the new residential use. The recovery of disused industrial spaces for residential use also has the positive aspect of avoiding the consumption of land with new buildings, subtracting the buildings from a condition of progressive degradation with evident recovery of the landscape. The English word loft, whose proper meaning is attic / ceiling, comes from the Old Norse "lopt" ("air", comparable with the German "luft", with the same meaning). The first experiences in the creation of lofts date back to the 1970s and originate from the setting up of house-ateliers by American artists near New York.

COLLECTIONS FRANCESCO

UN'ABITAZIONE RICAVATA DA UN AMBIENTE UNICO
A HOUSE MADE FROM A UNIQUE ENVIRONMENT



ARREDARE CON LA PROFESSIONALITÀ DEL DESIGN MODERNO CHE SI INTEGRA FRA FUNZIONALITÀ E GUSTO ESTETICO. Elementi d'arredo protagonisti di casa che vi aiutano a trascorrere ogni momento della vostra vita quotidiana da passare in famiglia o con un'allegria compagnia di amici. Articoli per ogni uso come la sala pranzo arredata da una vasta gamma di tavoli con struttura in cristallo, cristallo e legno, totalmente in legno o soluzioni abbinata a gambe in metallo, tutti accompagnati da una numerosa proposta di sedie di ogni tipologia da quella totalmente in legno fino a quelle imbottite. La zona soggiorno è il locale più vissuto della casa impreziosito da vetrine con o senza cassetti abbinata a credenze con ante battenti, ante e cassetti, ante scorrevoli e porta TV il tutto realizzato in diverse finiture e materiali per tutti i gusti in modo da personalizzare la vostra casa. Completano l'ampia collezione le librerie a muro o da centro stanza per suddividere un ampio locale o da protagonista in un loft e consolle abbinata ad attaccapanni e specchiere di estrema semplicità ma con una straordinaria personalità. Comodissimi i tavolini d'appoggio da collocare di fronte ai divani o a fianco a seconda delle esigenze.

FURNISH WITH THE PROFESSIONALISM OF MODERN DESIGN THAT INTEGRATES BETWEEN FUNCTIONALITY AND AESTHETIC TASTE. Furnishing elements protagonists of the home that help you to spend every moment of your daily life to spend with your family or with a cheerful company of friends. Items for every use such as the dining room furnished with a wide range of tables with crystal, crystal and wood structure, totally in wood or solutions combined with metal legs, all accompanied by a numerous proposal of chairs of all types from that totally in wood up to the padded ones. The living area is the most lived-in room in the house embellished with showcases with or without drawers combined with sideboards with hinged doors, doors and drawers, sliding doors and TV stands, all made in different finishes and materials for all tastes in order to personalize your home. The large collection is completed by wall-mounted or freestanding bookcases to divide a large room or as a protagonist in a loft and console combined with extremely simple cabinets and mirrors but with an extraordinary personality. The side tables are very comfortable to be placed in front of the sofas or next to them depending on your needs.



articolo **FR035**
sedia con fondino e schienale imbottiti.
chair with upholstered seat and back.
cm. l. 56 p. 46 h. 118 hs. 51

articolo **FR016**
tavolo rettangolare fisso. fixed rectangular table.
cm. l. 160 p. 90 h. 80

articolo **FR010**
credenza 2 porte 3 cassetti con intaglio.
2 doors sideboard 2 drawers with carving.
cm. l. 200 p. 60 h. 98

COLLECTION
FRANCESCO

230



HOMEVENTUNOCOLLECTIONS

HOMEVENTUNOCOLLECTIONS

231

articolo **FR035**
sedia con fondino e schienale imbottiti.
chair with upholstered seat and back.
cm. l. 56 p. 46 h. 118 hs. 51

articolo **FR016**
tavolo rettangolare fisso. fixed rectangular table.
cm. l. 160 p. 90 h. 80

articolo **FR010**
credenza 2 porte 3 cassetti con intaglio.
2 doors sideboard 2 drawers with carving.
cm. l. 200 p. 60 h. 98



articolo **FR065**
cornice quadrata traforata.
perforated square frame.
cm. l. 98 p. 3 h. 98

articolo **FR046**
consolle 1 cassetto con intaglio.
1 drawer console with carving.
cm. l. 120 p. 40 h. 96



COLLECTION FRANCESCO



articolo **FR001+FR002**
vetrina alzata 2 porte+base 4 cassetti con intaglio.
2 doors showcase+4 drawers base with carving.
cm. l. 150 p. 50 h. 216

articolo **FR010**
credenza 2 porte 3 cassetti con intaglio.
2 doors sideboard 3 drawers with carving.
cm. l. 200 p. 60 h. 98

articolo **FR015**
tavolo rettangolare fisso.
fixed rectangular table.
cm. l. 180 p. 90 h. 80

articolo **FR017**
tavolo rettangolare allungabile
con allunga centrale cm. 45.
extendable rectangular table
with central extension cm. 45.
cm. l. 180 p. 90 h. 80

articolo **FR035**
sedia con fondino e schienale imbottiti.
chair with upholstered seat and back.
cm. l. 56 p. 46 h. 118 hs. 51





COLLECTION
FRANCESCO

articolo **FR017**
tavolo rettangolare allungabile con allunga centrale cm. 45. extendable rectangular table with central extension cm. 45. cm. l. 180 p. 90 h. 80

articolo **FR032**
sedia con fondino e schienale imbottiti. chair with upholstered seat and back. cm. l. 56 p. 46 h. 118 hs. 51

articolo **FR010**
credenza 2 porte 3 cassetti con intaglio. 2 doors sideboard 3 drawers with carving. cm. l. 200 p. 60 h. 98

articolo **FR067**
cornice rettangolare traforata. perforated rectangular frame. cm. l. 150 sp. 3 h. 98

articolo **FR003+FR004**
vetrina alzata 2 porte+base 2 porte con intaglio. 2 doors showcase + 2 doors base with carving. cm. l. 150 p. 50 h. 216

FRANCESCO COLLECTION



COLLECTION FRANCESCO

articolo **FR018**
tavolo rettangolare allungabile con allunga
centrale cm. 45. extendable rectangular table
with central extension cm. 45.
cm. l. 160 p. 90 h. 80

articolo **FR032**
sedia con fondino e schienale imbottiti.
chair with upholstered seat and back.
cm. l. 56 p. 46 h. 118 hs. 51

articolo **FR010**
credenza 2 porte 3 cassetti con intaglio.
2 doors sideboard 3 drawers with carving.
cm. l. 200 p. 60 h. 98

articolo **FR067**
cornice rettangolare traforata.
perforated rectangular frame.
cm. l. 150 sp. 3 h. 98

articolo **FR003+FR004**
vetrina alzata 2 porte+base
2 porte con intaglio. 2 doors showcase
+ 2 doors base with carving.
cm. l. 150 p. 50 h. 216





articolo **FR018**
tavolo rettangolare allungabile con allunga
centrale cm. 45. extendable rectangular table
with central extension cm. 45.
cm. l. 160 p. 90 h. 80

articolo **FR035**
sedia con fondino e schienale imbottiti.
chair with upholstered seat and back.
cm. l. 56 p. 46 h. 118 hs. 51

articolo **FR003+FR004**
vetrina alzata 2 porte+base
2 porte con intaglio. 2 doors showcase
+ 2 doors base with carving.
cm. l. 150 p. 50 h. 216

articolo **FR010**
credenza 2 porte 3 cassetti con intaglio.
2 doors sideboard 3 drawers with carving.
cm. l. 200 p. 60 h. 98





articolo **FR012**
credenza 2 porte 2 cassetti.
2 doors sideboard 2 drawers.
cm. l. 135 p. 60 h. 98

articolo **FR084**
plafoniera da muro. wall ceiling light.
cm. l. 30 p. 15 h. 60



articolo **M32CL** cm. ø. 45
articolo **M33CL** cm. ø. 60
pomello con swarovski. knob with swarovski.



articolo **M30CL** cm. ø. 35
articolo **M31CL** cm. ø. 45
pomello con swarovski. knob with swarovski.



articolo **FR040**
tavolino da salotto rettangolare.
rectangular coffee table.
cm. l. 115 p. 65 h. 41

articolo **FR065**
cornice quadrata traforata.
perforated square frame.
cm. l. 98 sp. 3 h. 98

articolo **FR057**
comò bombato 2 cassetti.
shaped chest of 2 drawers.
cm. l. 160 p. 60 h. 98



articolo **FR041**
tavolino da salotto quadrato.
square coffee table.
cm. l. 90 p. 90 h. 41

COME PER GLI ALTRI SPAZI DELLA CASA, ANCHE PER LA ZONA LIVING LA SCELTA DI UNO STILE CLASSICO NON È MAI FUORI MODA. LA PERFETTA ARMONIA TRA SEMPLICITÀ ED ELEGANZA.

AS FOR THE OTHER SPACES OF THE HOUSE, ALSO FOR THE LIVING AREA THE CHOICE OF A CLASSIC STYLE IT IS NEVER OUT OF FASHION. THE PERFECT HARMONY BETWEEN SIMPLICITY AND ELEGANCE.

articolo FR005 SX+FR006

vetrina alzata 1 porta sinistra+base con intaglio.
1 leaf door showcase+base with carving.
cm. l. 88 p. 46 h. 205

articolo FR005 DX+FR006

vetrina alzata 1 porta destra+base con intaglio.
1 right door showcase+base with carving.
cm. l. 88 p. 46 h. 205

articolo FR037

pendente porta TV. TV stand wall unit.
cm. l. 158 p. 30 h. 128

articolo FR002

credenza 4 cassetti con intaglio.
4 drawers sideboard with carving.
cm. l. 170 p. 50 h. 66



articolo FR020

scrivania bombata 4 cassetti.
shaped 4 drawers writing desk.
cm. l. 160 p. 80 h. 80

articolo FR032

sedia con fondino e schienale imbottiti.
chair with upholstered seat and back.
cm. l. 56 p. 46 h. 118 hs. 51

articolo FR003 +FR004

vetrina alzata 2 porte+base 2 porte
con intaglio. 2 doors showcase
+ 2 doors base with carving.
cm. l. 150 p. 50 h. 216

COLLECTION FRANCESCO



articolo **FR035**
 sedia con fondino e schienale imbottiti.
 chair with upholstered seat and back.
 cm. l. 56 p. 46 h. 118 hs. 51

articolo **FR020**
 scrivania bombata 4 cassetti.
 shaped 4 drawers writing desk.
 cm. l. 160 p. 80 h. 80

articolo **FR032**
 sedia con fondino e schienale imbottiti.
 chair with upholstered seat and back.
 cm. l. 56 p. 46 h. 118 hs. 51



articolo **FR020**
 scrivania bombata 4 cassetti.
 shaped 4 drawers writing desk.
 cm. l. 160 p. 80 h. 80

articolo **FR032**
 sedia con fondino e schienale imbottiti.
 chair with upholstered seat and back.
 cm. l. 56 p. 46 h. 118 hs. 51

articolo **FR011**
 credenza 2 porte 2 cassetti.
 2 doors sideboard 2 drawers.
 cm. l. 160 p. 60 h. 98

COLLECTION
FRANCESCO





articolo **FR003 +FR004**
 vetrina alzata 2 porte+base 2 porte
 con intaglio. 2 doors showcase
 + 2 doors base with carving.
 cm. l. 150 p. 50 h. 216

articolo **FR020**
 scrivania bombata 4 cassetti.
 shaped 4 drawers writing desk.
 cm. l. 160 p. 80 h. 80

articolo **FR032**
 sedia con fondino e schienale imbottiti.
 chair with upholstered seat and back.
 cm. l. 56 p. 46 h. 118 hs. 51

articolo **FR011**
 credenza 2 porte 2 cassetti.
 2 doors sideboard 2 drawers.
 cm. l. 160 p. 60 h. 98



articolo FR046
consolle 1 cassetto con intaglio.
1 drawers console with carving.
cm. l. 120 p. 40 h. 96

articolo FR065
cornice quadrata traforata.
perforated square frame.
cm. l. 98 sp. 3 h. 98

articolo FR083
plafoniera da muro. wall ceiling light.
cm. l. 30 p. 15 h. 60

articolo FR035
sedia con fondino e schienale imbottiti.
chair with upholstered seat and back.
cm. l. 56 p. 46 h. 118 hs. 51

COLLECTION FRANCESCO



articolo FR012
credenza 2 porte 2 cassetti.
2 doors sideboard 2 drawers.
cm. l. 135 p. 60 h. 98



COLLECTION
FRANCESCO

articolo FR003+FR004
vetrina alzata 2 porte+base 2 porte con intaglio.
2 doors showcase + 2 doors base with carving.
cm. l. 150 p. 50 h. 216



COLLECTIONS
FRANCESCO BEDROOMS

UN'ABITAZIONE RICAVATA DA UN AMBIENTE UNICO
A HOUSE MADE FROM A UNIQUE ENVIRONMENT



articolo **FR058**
comodino 3 cassetti con intaglio.
3 drawers bedside table with carving.
cm. l. 58 p. 38 h. 66

articolo **FR061**
letto matrimoniale con testata imbottita.
double bed with upholstered headboard.
cm. l. 202 p. 208 h. 153

articolo **FR068**
cornice rotonda traforata.
perforated round frame.
cm. ø. 95 sp. 3

articolo **FR056**
comò 4 cassetti con intaglio.
chest of 4 drawers table with carving.
cm. l. 135 p. 60 h. 98



COLLECTION
FRANCESCO



articolo **FR054**
armadio 4 ante battenti con intaglio.
4 hinged doors wardrobe with carving.
cm. l. 255 p. 65 h. 220

articolo **FR058**
comodino 3 cassetti con intaglio.
3 drawers bedside table with carving.
cm. l. 58 p. 38 h. 66



articolo **FR061**
letto matrimoniale con testata imbottita.
double bed with upholstered headboard.
cm. l. 202 p. 208 h. 153

articolo **FR056**
comò 4 cassetti con intaglio.
chest of 4 drawers table with carving.
cm. l. 135 p. 60 h. 98





articolo **FR053**
armadio 3 ante battenti con intaglio.
3 hinged doors wardrobe with carving.
cm. l. 196 p. 65 h. 220



articolo **FR068**
cornice rotonda traforata.
perforated round frame.
cm. ø. 95 sp. 3

articolo **FR056**
comò 4 cassetti con intaglio.
chest of 4 drawers table with carving.
cm. l. 135 p. 60 h. 98

articolo **FR052**
armadio 3 ante battenti con intaglio.
3 hinged doors wardrobe with carving.
cm. l. 136 p. 65 h. 220



articolo **FR063**
letto matrimoniale testata e giroletto imbottiti.
double bed with upholstered headboard bed frame.
cm. l. 222 p. 216 h. 155



articolo **FR060**
letto matrimoniale con testata imbottita.
double bed with upholstered headboard.
cm. l. 222 p. 208 h. 153

articolo **FR061**
letto matrimoniale con testata imbottita.
double bed with upholstered headboard.
cm. l. 202 p. 208 h. 153

COLLECTION FRANCESCO



articolo **FR058**
comodino 3 cassetti con intaglio.
3 drawers bedside table with carving.
cm. l. 58 p. 38 h. 66

articolo **FR059**
toilette 2 cassetti piano apribile.
dressing table 2 drawers opening top.
cm. l. 120 p. 50 h. 80

articolo **FR032**
sedia con fondino e schienale imbottiti.
chair with upholstered seat and back.
cm. l. 56 p. 46 h. 118 hs. 51

articolo **FR073**
panchetta imbottita. upholstered bench.
cm. l. 140 p. 54 h. 52

articolo **FR060**
letto matrimoniale con testata imbottita.
double bed with upholstered headboard.
cm. l. 222 p. 208 h. 153

articolo **FR061**
letto matrimoniale con testata imbottita.
double bed with upholstered headboard.
cm. l. 202 p. 208 h. 153

articolo **FR051**
armadio 2 ante scorrevoli con specchio.
2 sliding doors wardrobe with mirror.
cm. l. 225 p. 66 h. 228

COLLECTION
FRANCESCO

articolo **FR058**
comodino 3 cassetti con intaglio.
3 drawers bedside table with carving.
cm. l. 58 p. 38 h. 66

articolo **FR059**
toilette 2 cassetti piano apribile.
dressing table 2 drawers opening top.
cm. l. 120 p. 50 h. 80

articolo **FR032**
sedia con fondino e schienale imbottiti.
chair with upholstered seat and back.
cm. l. 56 p. 46 h. 118 hs. 51



articolo **FR080**
piantana grande. big floor lamp.
cm. ø. 65 h. 178



articolo **FR081**
piantana media. medium floor lamp.
cm. ø. 50 h. 73



articolo **FR082**
piantana piccola. small floor lamp.
cm. ø. 50 h. 62



articolo **FR084**
plafoniera da muro. wall lamp.
cm. l. 30 p. 15 h. 60



articolo **FR058**
comodino 3 cassetti con intaglio.
3 drawers bedside table with carving.
cm. l. 58 p. 38 h. 66



articolo **FR055**
comò 4 cassetti con intaglio
chest of 4 drawers with carving.
cm. l. 170 p. 60 h. 98



articolo **FR063**
letto matrimoniale testata e giroletto imbottiti.
double bed upholstered headboard bed frame.
cm. l. 222 p. 216 h. 155

articolo **FR055**
comò 4 cassetti con intaglio
chest of 4 drawers with carving.
cm. l. 170 p. 60 h. 98

articolo **FR058**
comodino 3 cassetti con intaglio.
3 drawers bedside table with carving.
cm. l. 58 p. 38 h. 66

articolo **FR067**
cornice rotonda traforata specchio liscio.
round perforated frame smooth mirror.
cm. ø. 95 sp. 3



COLLECTION
FRANCESCO



articolo **FR001+FR002**
vetrina libreria base 4 cassetti+alzata 2 porte.
cm. l. 170 p. 50 h. 215



articolo **FR003+FR004**
vetrina base 2 porte+alzata 2 porte.
cm. l. 150 p. 50 h. 215



articolo **FR005DX+FR006**
vetrina base 1 cestone+alzata 1 porta destra.
cm. l. 88 p. 46 h. 205



articolo **FR005SX+FR006**
vetrina base 1 cestone+alzata 1 porta sinistra.
cm. l. 88 p. 46 h. 205



articolo **FR015**
tavolo rettangolare fisso.
cm. l. 180 p. 90 h. 80



articolo **FR016**
tavolo rettangolare fisso.
cm. l. 160 p. 90 h. 80



articolo **FR017**
tavolo rettangolare 1 allunga centrale cm. 45.
cm. l. 180/225 p. 90 h. 80



articolo **FR018**
tavolo rettangolare 1 allunga centrale cm. 45.
cm. l. 160/205 p. 90 h. 80



articolo **FR002**
base panca porta TV 4 cassetti.
cm. l. 170 p. 50 h. 66



articolo **FR004**
base panca porta TV 2 porte.
cm. l. 150 p. 50 h. 66



articolo **FR006**
base panca porta TV 1 cestone.
cm. l. 88 p. 46 h. 66



articolo **FR032**
sedia con fondino e schienale imbottiti.
cm. l. 52 p. 46 h. 110 h.s. 51



articolo **FR033**
sedia con fondino e schienale imbottiti.
cm. l. 56 p. 46 h. 110 h.s. 51



articolo **622/G**
sedia con fondino imbottito.
cm. l. 46 p. 41,5 h. 95,5 h.s. 45,5



articolo **375/G**
sedia con fondino imbottito.
cm. l. 46 p. 45 h. 91,5 h.s. 45,5



articolo **FR010**
credenza 2 porte 3 cassetti.
cm. l. 200 p. 60 h. 98



articolo **FR011**
credenza 2 porte 2 cassetti.
cm. l. 160 p. 60 h. 98



articolo **FR012**
credenza 2 porte 2 cassetti.
cm. l. 135 p. 60 h. 98



articolo **FR037**
pensile da muro porta TV.
cm. l. 158 p. 30 h. 128



articolo **FR037**
scrivania porta computer 4 cassetti.
cm. l. 160 p. 80 h. 80



articolo **FR040**
tavolino rettangolare da salotto.
cm. l. 115 p. 65 h. 41



articolo **FR040**
tavolino quadrato da salotto.
cm. l. 90 p. 90 h. 41

COLLECTION
FRANCESCO

ELEMENTI SINGOLI ZONA NOTTE
BEDROOM SINGLE ELEMENTS



articolo **FR045**
consolle sagomata 2 cassetti.
cm. l. 150 p. 42 h. 96



articolo **FR046**
consolle sagomata 1 cassetto.
cm. l. 120 p. 40 h. 96



articolo **FR051**
armadio 2 porte sorrevoli con specchio.
cm. l. 225 p. 66 h. 257



articolo **FR052**
armadio 2 porte battenti.
cm. l. 136 p. 65 h. 220



articolo **FR053**
armadio 3 porte battenti.
cm. l. 196 p. 65 h. 220



articolo **FR054**
armadio 3 porte battenti.
cm. l. 256 p. 65 h. 220



articolo **FR060**
letto matrimoniale con testata imbottita.
cm. l. 222 p. 208 h. 153



articolo **FR061**
letto matrimoniale con testata imbottita.
cm. l. 202 p. 208 h. 153



articolo **FR063**
letto matrimoniale imbottito.
cm. l. 222 p. 216 h. 155



articolo **FR073**
panchetta imbottita in tessuto.
cm. l. 140 p. 54 h. 52



articolo **FR055**
comò sagomato 4 cassetti.
cm. l. 170 p. 60 h. 98



articolo **FR056**
comò sagomato 4 cassetti.
cm. l. 135 p. 60 h. 98



articolo **FR057**
comò sagomato 2 cassetti.
cm. l. 102 p. 45 h. 86



articolo **FR058**
comodino sagomato 3 cassetti.
cm. l. 58 p. 38 h. 66

COLLECTION
FRANCESCO

MANIGLIE HANDLES

FINITURE MANIGLIE CL: CROMO LUCIDO
BO: BAGNO ORO ZECCHINO



articolo **M30CL** cm. ø. 35

articolo **M31CL** cm. ø. 45

pomello con swarovski. knob with swarovski.



articolo **M32CL** cm. ø. 45

articolo **M33CL** cm. ø. 60

pomello con swarovski. knob with swarovski.



articolo **M34CL** cm. ø. 35

articolo **M35CL** cm. ø. 60

maniglia cromo lucido. polished chrome handle.



articolo **M30BO** cm. ø. 35

articolo **M31BO** cm. ø. 45

pomello con swarovski. knob with swarovski.



articolo **M32BO** cm. ø. 45

articolo **M33BO** cm. ø. 60

pomello con swarovski. knob with swarovski.



articolo **M34BO** cm. ø. 35

articolo **M35BO** cm. ø. 60

maniglia bagno oro. gold-plated handle.



articolo **FR059**
consolle 2 cassetti piano apribile con specchio.
cm. l. 120 p. 50 h. 80



articolo **FR065**
cornice quadrata traforata specchio liscio.
cm. l. 98 sp. 3 h. 98



articolo **FR066**
cornice rettangolare traforata specchio liscio.
cm. l. 150 sp. 3 h. 98



articolo **FR067**
cornice rotonda traforata specchio liscio.
cm. ø. 95 sp. 3

COLLECTION
FRANCESCO

PIANTANE, LAMPADE, MANIGLIE E TESSUTI
STANDS, LAMPS, HANDLES AND FABRICS

articolo FR080
piantana grande.
cm. h. totale 200



articolo FR081
piantana media.
cm. h. totale 92



articolo FR082
piantana piccola.
cm. h. totale 84



articolo FR083
plafoniera da muro.
cm. l. 30 p. 15 h. 60



articolo FR080
piantana grande.
cm. h. totale 178



articolo FR081
piantana media.
cm. h. totale 73



articolo FR082
piantana piccola.
cm. h. totale 62



articolo FR084
plafoniera da muro.
cm. l. 30 p. 15 h. 60



VELLUTO BLU G074/520



VELLUTO BIANCO G074/500



VELLUTO NOCCIOLA G074/506



VELLUTO PANCHETTA G076/204



SKY CASTING 11312



PUNTINO BLU CLG 067-05



PUNTINO BIANCO CLG 067-01



FIORE BIANCO CLG 06-01

COLLECTIONS

BELVEDERE





articolo 920/G
tavolino piano con vetro e cassetto.
coffee table with glass top and drawers.
cm. l. 120 p. 60 h. 47

articolo 667/G
porta TV 2 porte 1 cassetto e vani.
2 doors TV stand 1 drawers compartment.
cm. l. 123 p. 41 h. 55

articolo 668/G
vetrina 1 porta vetro destra o sinistra.
showcase 1 glass door right or left.
cm. l. 47 p. 36 h. 140

articolo 666/G
credenza 2 porte 2 cassetti.
2 doors sideboard 2 drawers.
cm. l. 124 p. 46 h. 100

COLLECTION BELVEDERE

HOMEVENTUNOCOLLECTIONS



articolo **378/G**
 sedia laccata con fondino paglia.
 lacquered chair with straw seat.
 cm. l. 46 p. 45 h. 91,5 hs. 45,5

articolo **276/G**
 scrittoio 3 cassetti piano legno.
 3 drawers writing desk wooden top.
 cm. l. 120 p. 64 h. 78

articolo **622/G**
 sedia con fondino imbottito.
 chair with upholstered seat.
 cm. l. 46 p. 41,5 h. 95,5 h.s. 45,5

articolo **277/G**
 scrittoio 5 cassetti piano legno.
 5 drawers writing desk wooden top.
 cm. l. 160 p. 75 h. 78

articolo **283/G**
 libreria 4 porte ripiani legno.
 4 doors bookcase with wooden shelves.
 cm. l. 200 p. 53 h. 220



COLLECTION BELVEDERE

articolo 203/G
credenza 2 porte 2 cassetti.
2 doors sideboard 2 drawers.
cm. l. 157 p. 52 h. 93

articolo 234/G
tavolo rettangolare allungabile 2 allunghe
laterali da cm. 44. extendable rectangular table
with 2 side extensions of cm. 44.
cm. l. 180 p. 90 h. 77

articolo 204/G
cristalliera 3 porte 3 cassetti.
crystal cabinet 3 doors 3 drawers.
cm. l. 220 p. 52 h. 222



articolo 408/G
sedia con fondino imbottito.
chair with upholstered seat.
cm. l. 44 p. 43 h. 93,5 hs. 45,5

articolo 200/G
credenza 2 porte 6 cassetti.
2 doors sideboard 6 drawers.
cm. l. 220 p. 52 h. 100

articolo 234/G
tavolo rettangolare allungabile 2 allunghe
laterali da cm. 44. extendable rectangular table
with 2 side extensions of cm. 44.
cm. l. 180 p. 90 h. 77

articolo 202/G
cristalliera 2 porte 2 cassetti.
crystal cabinet 2 doors 2 drawers.
cm. l. 157 p. 52 h. 223

COLLECTION BELVEDERE



articolo 375/G
sedia con fondino paglia. chair with straw seat.
cm. l. 46 p. 45 h. 91,5 hs. 45,5

278



HOMEVENTUNOCOLLECTIONS

HOMEVENTUNOCOLLECTIONS

279



articolo 200/G
credenza 2 porte 6 cassetti.
2 doors sideboard. 6 drawers.
cm. l. 220 p. 52 h. 100



articolo 213/G
porta TV 2 porte e vano.
2 doors TV stand and compartement.
cm. l. 108 p. 45 h. 95



articolo 203/G
credenza 2 porte 2 cassetti.
2 doors sideboard 2 drawers.
cm. l. 157 p. 52 h. 93



articolo 204/G
cristalliera 3 porte 3 cassetti.
crystal cabinet 3 doors 3 drawers.
cm. l. 220 p. 52 h. 222



articolo 207/G
credenza 3 porte 3 cassetti.
3 doors sideboard. 3 drawers.
cm. l. 220 p. 52 h. 93



particolare formella. tile detailed.



articolo **887/GB**
porta TV 2 porte 3 cassetti.
2 doors TV stand 3 drawers.
cm. l. 209 p. 43 h. 67

articolo **1904/G**
vetrina 1 porta con formelle.
1 door showcase with tiles.
cm. l. 113 p. 48 h. 212



COLLECTION
BELVEDERE

284

HOMEVENTUNOCOLLECTIONS



particolare formella. tile detailed.

articolo 1887/G
libreria 2 porte 2 porte scorrevoli 3 cassetti
con formelle foglia. bookcase 2 doors 2 sliding
doors 3 drawers with leaf tiles.
cm. l. 212 p. 45 h. 220

articolo 903/G
porta TV 2 antine apribili e vani.
TV stand 2 opening doors and compartments.
cm. l. 104 p. 48 h. 83

HOMEVENTUNOCOLLECTIONS

285

BELVEDERE COLLECTION



articolo 1902/G
credenza 2 porte 2 cassetti con formelle foglia.
2 doors sideboard 2 drawers with leaf tiles.
cm. l. 213 p. 54 h. 124

articolo 234/G
tavolo rettangolare allungabile 2 allunghe
laterali da cm. 44. extendable rectangular table
with 2 side extensions of cm. 44.
cm. l. 180 p. 90 h. 77

articolo 750/G
fusto da imbottire. chair frame for upholstered.
cm. l. 50 p. 50 h. 104 h.s. 43

articolo 1901/G
vetrina 2 porte con formelle foglia.
2 doors showcase with leaf tiles.
cm. l. 145 p. 48 h. 212

COLLECTION
BELVEDERE





particolare formella. tile detailed.

articolo 887/GB
porta TV 2 porte 3 cassetti.
2 doors TV stand 3 drawers.
cm. l. 209 p. 43 h. 67

articolo 1899/G
cristalliera 2 porte 3 cassetti.
crystal cabinet 2 doors 3 drawers.
cm. l. 213 p. 54 h. 226

COLLECTION BELVEDERE



particolare formella. tile detailed.



articolo 1900/G
credenza 2 porte 2 cassetti.
2 doors sideboard 2 drawers.
cm. l. 213 p. 48 h. 114

articolo 1904/G
vetrina 1 porta con formelle.
1 door showcase with tiles.
cm. l. 113 p. 48 h. 212





particolare formella. tile detailed.

articolo 1887/G
libreria 2 porte 2 porte scorrevoli 3 cassetti
con formelle foglia. bookcase 2 doors 2 sliding
doors 3 drawers with leaf tiles.
cm. l. 212- p. 45 h. 220

articolo 888/G
scrivania 1 anta e cassetti.
writing desk with 1 door and drawers.
cm. l. 160 p. 80 h. 85

COLLECTION
BELVEDERE

articolo 2/G
 scrivania porta computer 1 porta 1 cassetto
 e tiretto porta tastiera. computer writing desk
 1 door 1 drawer and keyboard puller.
 cm. l. 99 p. 59 h. 81



COLLECTION BELVEDERE



articolo 4/G
 scrivania porta computer 1 porta 5 cassetti
 e tiretto porta tastiera. computer writing desk
 1 door 5 drawers and keyboard puller.
 cm. l. 127 p. 59 h. 81



articolo 5007/G
 scrittoio sagomata 3 cassetti.
 3 drawers shaped writing desk.
 cm. l. 140 p. 65 h. 78

articolo 5008/G
 scrittoio sagomata 3 cassetti.
 3 drawers shaped writing desk.
 cm. l. 160 p. 65 h. 78

articolo 5006/G
 scrittoio sagomata 3 cassetti.
 3 drawers shaped writing desk.
 cm. l. 110 p. 65 h. 78



COLLECTIONS BELVEDERE NIGHT



COLLECTION BELVEDERE

articolo 5076/G
scrivania 1 porta portafrigo.
writing desk 1 door refrigerator container.
cm. l. 110 p. 60 h. 78

articolo 5079/G
porta valigie, suitcase support.
cm. l. 70 p. 45 h. 50

articolo 5080/G
cornice per specchio, frame with mirror.
cm. l. 66 sp. 3 h. 160

articolo 5066/G
letto singolo testata legno.
single bed with wooden headboard.
cm. l. 96 p. 206 h. 105

articolo 5067/G
comodino con 2 cassetti.
2 drawers bedside table.
cm. l. 45 p. 35 h. 55

COLLECTION BELVEDERE

articolo 5065/G
comò con 4 cassetti.
chest of drawers with 4 drawers.
cm. l. 100 p. 50 h. 107

articolo 5068/G
cornice specchio liscio.
frame smooth mirror.
cm. l. 75 p. 5 h. 105

articolo 5072/G
letto matrimoniale testata legno.
double bed with wooden headboard.
cm. l. 180 p. 206 h. 105

articolo 5067/G
comodino con 2 cassetti.
2 drawers bedside table.
cm. l. 45 p. 35 h. 55

articolo 5073/G
armadio 3 ante battenti.
wardrobe with 3 hinged doors.
cm. l. 156 p. 57 h. 215





COLLECTION BELVEDERE

articolo **5065/G**
comò con 4 cassetti.
chest of drawers with 4 drawers.
cm. l. 100 p. 50 h. 107

articolo **5068/G**
cornice per specchio.
frame with mirror.
cm. l. 75 p. 5 h. 105

articolo **5073/G**
armadio 3 ante battenti.
wardrobe with 3 hinged doors.
cm. l. 156 p. 57 h. 215





articolo 5065/G
comò con 4 cassetti.
chest of drawers with 4 drawers.
cm. l. 100 p. 50 h. 107

articolo 5068/G
cornice specchio liscio.
frame smooth mirror.
cm. l. 75 p. 5 h. 105

articolo 5070/G
armadio 2 ante battenti con cassetto.
2 hinged doors wardrobe with drawer.
cm. l. 106 p. 57 h. 215

articolo 5069/G
letto 1 piazza e mezza testata legno.
single double bed with wooden headboard.
cm. l. 130 p. 206 h. 105





articolo 5069/G
letto 1 piazza e mezza testata legno.
single double bed with wooden headboard.
cm. l. 130 p. 206 h. 105

articolo 5066/G
letto singolo testata legno.
single bed with wooden headboard.
cm. l. 96 p. 206 h. 105

articolo 5077/G
comodino 1 cassetto e ripiano.
1 darwer bedside table and shelf.
cm. l. 45 p. 35 h. 55



articolo 5067/G
comodino con 2 cassetti.
2 darwers bedside table.
cm. l. 45 p. 35 h. 55



articolo 5079/G
porta valigie, suitcase support.
cm. l. 70 p. 45 h. 50

articolo 5080/G
cornice con specchio liscio.
frame with smooth mirror.
cm. l. 66 sp. 3 h. 160



articolo 5082/G
cornice da terra con specchio liscio.
floor frame with smooth mirror.
cm. l. 84 sp. 3 h. 205



articolo 5071/G
armadio 2 ante battenti.
wardrobe with 2 hinged doors.
cm. l. 106 p. 57 h. 215

articolo 5081/G
armadio 2 ante battenti.
wardrobe with 2 hinged doors.
cm. l. 126 p. 57 h. 215



articolo 5070/G
armadio 2 ante battenti con cassetto.
2 hinged doors wardrobe with drawer.
cm. l. 106 p. 57 h. 215

articolo 5078/G
armadio 2 ante battenti con cassetto.
2 hinged doors wardrobe with drawer.
cm. l. 126 p. 57 h. 215



COLLECTION
BELVEDERE



COLLECTION
BELVEDERE

articolo 5076/G
scrivania 1 porta portafrigo.
writing desk 1 door refrigerator container.
cm. l. 110 p. 60 h. 78

articolo 893/G
servomuto, suit stand.
cm. l. 45 p. 30 h. 97



articolo 821/G
armadio 4 ante battenti cappello a gendarme.
4 hinged doors wardrobe with gendarme hat.
cm. l. 206 p. 55 h. 197

articolo 183/G
cornice con specchio liscio.
frame with smooth mirror.
cm. l. 75 p. 3 h. 105

articolo 182/G
comò con 4 cassetti.
chest of drawers with 4 drawers.
cm. l. 123 p. 54 h. 108

articolo 905/G
armadio 2 ante battenti cappello a gendarme.
2 hinged doors wardrobe with gendarme hat.
cm. l. 107 p. 55 h. 197

articolo 181/G
letto singolo testata legno.
single bed with wooden headboard.
cm. l. 103 p. 214 h. 93

articolo 184/G
comodino con 3 cassetti.
3 drawers bedside table.
cm. l. 53 p. 38 h. 63

articolo 906/G
armadio 3 ante battenti cappello a gendarme.
3 hinged doors wardrobe with gendarme hat.
cm. l. 157 p. 55 h. 197





articolo 5032/G
comodino con 2 cassetti.
2 drawers bedside table.
cm. l. 58 p. 36 h. 55

articolo 5031/G
letto matrimoniale con pannello ecopelle.
double bed with eco-leather panel.
cm. l. 180 p. 212 h. 125

articolo 5030/G
armadio 2 ante scorrevoli a giorno.
2 sliding compartments doors wardrobe.
cm. l. 295 p. 66 h. 250

articolo 5030/GB
armadio 2 ante scorrevoli a vetro.
2 sliding glass doors wardrobe.
cm. l. 230 p. 66 h. 250

COLLECTION BELVEDERE

articolo 5033/G
comò con 4 cassetti.
chest of drawers with 4 drawers.
cm. l. 132 p. 54 h. 100

articolo 5032/G
comodino con 2 cassetti.
2 drawers bedside table.
cm. l. 58 p. 36 h. 55

articolo 5031/GC
letto singolo con testata legno.
single bed with wooden headboard.
cm. l. 96 p. 206 h. 32/125

articolo 5031/GC
letto 1 piazza e mezza con testata legno.
single double bed with wooden headboard.
cm. l. 130 p. 206 h. 125



COLLECTION
BELVEDERE

articolo 5030/G
armadio 2 ante scorrevoli+KIT PANNELLI LEGNO.
2 sliding doors wardrobe+WOODEN PANEL KIT.
cm. l. 295 p. 66 h. 250

articolo 5030/GB
armadio 2 ante scorrevoli+KIT PANNELLI LEGNO.
2 sliding doors wardrobe+WOODEN PANEL KIT.
cm. l. 230 p. 66 h. 250





articolo 5032/G
comodino con 2 cassetti.
2 drawers bedside table.
cm. l. 58 p. 36 h. 55

articolo 5031/G
letto matrimoniale con pannello ecopelle.
double bed with eco-leather panel.
cm. l. 180 p. 212 h. 125

articolo 5033/G
comò con 4 cassetti.
chest of drawers with 4 drawers.
cm. l. 132 p. 54 h. 100



articolo 5030/G
armadio 2 ante scorrevoli a giorno.
2 sliding compartments doors wardrobe.
cm. l. 295 p. 66 h. 250

articolo 5030/GB
armadio 2 ante scorrevoli a vetro.
2 sliding compartments doors wardrobe.
cm. l. 230 p. 66 h. 250



articolo 815/G
comodino con 3 cassetti.
3 drawers bedside table.
cm. l. 53 p. 38 h. 64

articolo 813/G
comò con 4 cassetti.
chest of drawers with 4 drawers.
cm. l. 123 p. 54 h. 106

articolo 812/G
letto matrimoniale con testata traforata.
double bed with perforated headboard.
cm. l. 176 p. 210 h. 105

articolo 814/G
cornice con specchio liscio.
frame with smooth mirror.
cm. l. 100 p. 7 h. 90

COLLECTION
BELVEDERE





articolo 818/G
armadio 3 ante scorrevoli a giorno.
3 sliding compartment doors wardrobe.
cm. l. 285 p. 66 h. 250

COLLECTION
BELVEDERE

articolo 817/G
armadio 3 ante scorrevoli con pannelli legno.
3 sliding doors wardrobe with wood panels.
cm. l. 285 p. 66 h. 250





articolo 5047/G
comodino con 3 cassetti.
3 drawers bedside table.
cm. l. 65 p. 39 h. 72

articolo 5048/G
letto matrimoniale testata pannello ecopelle.
double bed headboard eco-leather panel.
cm. l. 192 p. 208 h. 137

articolo 5049/G
comò con 4 cassetti e ribalta.
chest of 4 drawers with flap doors.
cm. l. 145 p. 57 h. 128



COLLECTION
BELVEDERE





articolo **183/G**
cornice con specchio liscio.
frame with smooth mirror.
cm. l. 75 p. 3 h. 105

articolo **182/G**
comò con 4 cassetti.
chest of drawers with 4 drawers.
cm. l. 123 p. 54 h. 108

articolo **181/G**
letto matrimoniale con testata legno.
double bed with wooden headboard.
cm. l. 186 p. 213 h. 98

articolo **184/G**
comodino con 3 cassetti.
3 drawers bedside table.
cm. l. 53 p. 38 h. 63

COLLECTION
BELVEDERE

322

HOMEVENTUNOCOLLECTIONS



HOMEVENTUNOCOLLECTIONS

323

BELVEDERE COLLECTION



COLLECTION
BELVEDERE

articolo 185/G
armadio con 6 ante battenti.
wardrobe with 6 hinged doors.
cm. l. 289 p. 60 h. 247

articolo 184/G
comodino con 3 cassetti.
3 drawers bedside table.
cm. l. 53 p. 38 h. 63

articolo 182/G
comò con 4 cassetti.
chest of drawers with 4 drawers.
cm. l. 123 p. 54 h. 108





particolare formella. tile detailed.

articolo 1889/G
comò con 5 cassetti. chest of 4 drawers.
cm. l. 130 p. 52 h. 120

articolo 1891/G
letto matrimoniale con testata legno.
double bed with wooden headboard.
cm. l. 188 p. 212 h. 117

articolo 893/G
servomuto. suit stand.
cm. l. 45 p. 30 h. 97

articolo 1894/G
comodino con 3 cassetti.
3 drawers bedside table.
cm. l. 64 p. 36 h. 70

articolo 1896/G
cornice con specchio liscio.
frame with smooth mirror.
cm. l. 81 p. 8 h. 106

COLLECTION BELVEDERE



COLLECTION
BELVEDERE



articolo 1895/G
comò 4 cassetti con ribalta e segreti.
chest of 4 drawers with flap doors and secrets.
cm. l. 130 p. 52 h. 120

articolo 1896/G
cornice con specchio liscio.
frame with smooth mirror.
cm. l. 81 p. 8 h. 106

articolo 1892/G
armadio con 4 ante battenti.
wardrobe with 4 hinged doors.
cm. l. 293 p. 66 h. 250





COLLECTIONS

BELVEDERE BATHROOM

UN'ABITAZIONE RICAVATA DA UN AMBIENTE UNICO
A HOUSE MADE FROM A UNIQUE ENVIRONMENT

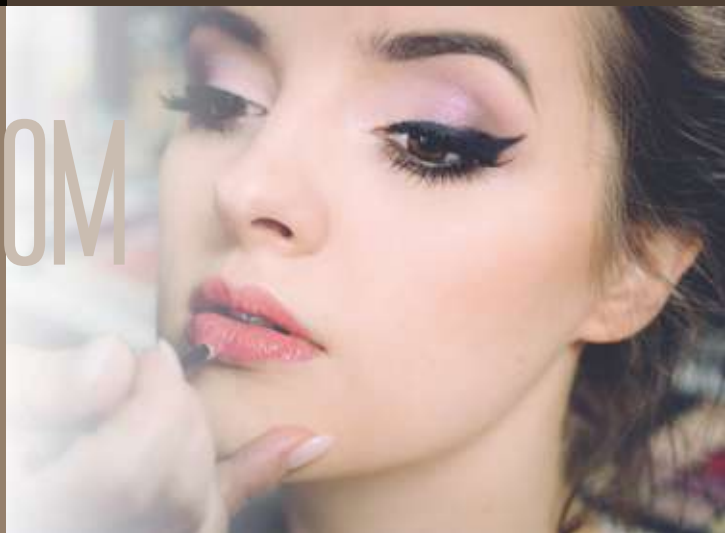



articolo **MB 102**
cassettiera 4 cassetti 1 ribalta 1 porta vetro.
4 drawers dresser 1 flap door 1 glass door.
cm. l. 44 p. 41 h. 182



articolo **DEDOR 2**
composizione bagno. bathroom composition.
cm. l. 97 p. 60

articolo **893/G**
servomuto. suit stand. cm. l. 45 p. 30 h. 97

articolo **MB152**
pensile a giorno. open hanging.
cm. l. 40 p. 17 h. 40

articolo **DECOR 3**
composizione bagno con cassetti laterali.
bathroom composition with side drawers.
cm. l. 123 p. 60



disponibile: available:
articolo **DECOR 7**
composizione bagno con ante laterali.
bathroom composition with side doors.
cm. l. 123 p. 60

articolo **MB 100**
cassettiera con 7 cassetti.
drawers dresser with 7 drawers.
cm. l. 67 p. 41 h. 134



COLLECTION
BELVEDERE



COLLECTION BELVEDERE

articolo **DECOR 1**
composizione bagno. bathroom composition.
cm. l. 70 p. 60 h. 85



articolo **DECOR 7**
composizione bagno. bathroom composition.
cm. l. 70 p. 60 h. 85

articolo **MB 102**
cassettiera 4 cassetti 1 ribalta 1 porta vetro.
4 drawers dresser 1 flap door 1 glass door.
cm. l. 44 p. 41 h. 182



articolo **DECOR 6**
composizione bagno. bathroom composition.
cm. l. 213 p. 60



articolo DECOR 4
composizione bagno. bathroom composition.
cm. l. 161 p. 60



articolo DECOR 7 OPEN
composizione bagno. bathroom composition.
cm. l. 123 p. 60



articolo DECOR 1
composizione bagno. bathroom composition.
cm. l. 70 p. 60



COLLECTION BELVEDERE

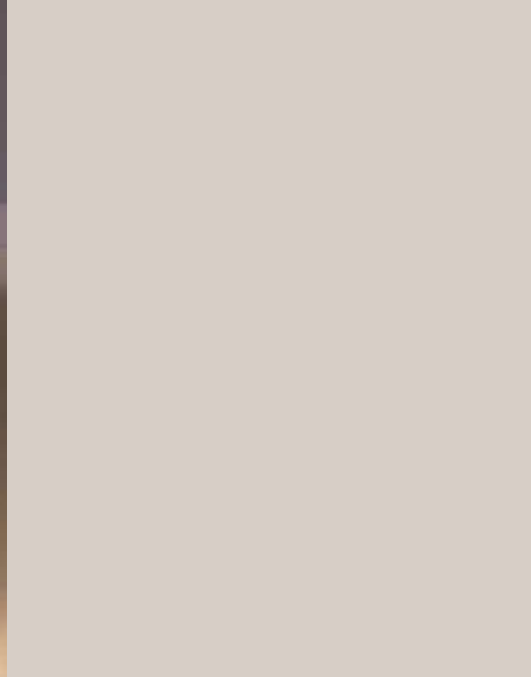

COLLECTION BELVEDERE

articolo **STYLE 7**
composizione bagno. bathroom composition.
cm. l. 170 p. 50





articolo **MB 102**
cassettiera 4 cassetti 1 ribalta 1 porta vetro.
4 drawers dresser 1 flap door 1 glass door.
cm. l. 44 p. 41 h. 182

articolo **MB 101**
vetrinetta 1 porta vetro satinato.
small showcase 1 satin glass door.
cm. l. 67 p. 41 h. 134

COLLECTION BELVEDERE COMPLEMENTS



articolo **668/G**
vetrinetta 1 porta vetro satinato.
small showcase 1 satin glass door.
cm. l. 47 p. 36 h. 140



articolo **897/G**
vetrinetta 1 porta vetro 2 cassettini.
1 glass door small showcase 2 drawers.
cm. l. 27 p. 27 h. 94



articolo **559/G**
vetrinetta 1 porta vetro 2 cassettini.
1 glass door small showcase 2 drawers.
cm. l. 49 p. 46 h. 143



articolo **560/G**
vetrina 1 porta vetro. showcase 1 glass door.
cm. l. 49 p. 46 h. 181



articolo MB 100
cassettiera con 7 cassetti.
drawers dresser with 7 drawers.
cm. l. 67 p. 41 h. 134



articolo 220/G
cassettiera con 7 cassetti.
drawers dresser with 7 drawers.
cm. l. 90 p. 48 h. 147



articolo EC-032
cornice da terra con specchio liscio.
floor frame with smooth mirror.
cm. l. 90 h. 200



articolo 5079/G
porta valigie. support suitcase.
cm. l. 70 p. 45 h. 50



articolo 912/G
pannello ingresso con specchio.
entrance panel with mirror.
cm. l. 107 p. 8 h. 209



COLLECTION
BELVEDERE



COLLECTION BELVEDERE



articolo 910/G
 pannello ingresso con specchio e cassetto.
 entrance panel with mirror and drawer.
 cm. l. 131 p. 23 h. 209



articolo 913/G
 pannello ingresso con specchio.
 entrance panel with mirror.
 cm. l. 94 p. 23 h. 209



articolo 227/G
 pannello per ingresso con specchio e 2 cassetti.
 entrance panel with mirror and 2 drawers.
 cm. l. 123 p. 30 h. 210



articolo 7/G
consolle mezzaluna. half-moon console.
cm. l. 60 p. 30 h. 72



articolo 6/G
consolle mezzaluna. half-moon console.
cm. l. 60 p. 30 h. 72



articolo 271/G
consolle 1 cassetto. 1 drawer console.
cm. l. 71 p. 40 h. 75



articolo 272/G
consolle 1 cassetto. 1 drawer console.
cm. l. 98 p. 40 h. 82



articolo 8/G
consolle angolo. corner console.
cm. l. 60 p. 32 h. 72



articolo 911/G
consolle 2 cassetti. s. darwers console.
cm. l. 100 p. 32 h. 86



COLLECTION BELVEDERE

articolo 5003/G
tavolino rettangolare piano legno.
rectangular coffee table wooden top.
cm. l. 120 p. 80 h. 45



articolo 5002/G
tavolino rettangolare piano legno.
rectangular coffee table wooden top.
cm. l. 100 p. 100 h. 45



articolo 1001/G
tavolino rettangolare piano massello.
rectangular coffee table solid wood top.
cm. l. 100 p. 50 h. 47

articolo 1000/G
tavolino rettangolare piano vetro.
rectangular coffee table glass top.
cm. l. 100 p. 55 h. 45



articolo 1003/G
tavolino quadrato piano massello.
square coffee table solid wood top.
cm. l. 60 p. 60 h. 47

articolo 1005/G
tavolino quadrato piano massello.
square coffee table solid wood top.
cm. l. 70 p. 70 h. 47



articolo 920/G
tavolino rettangolare con cassetto
e piano a bacheca. rectangular coffee table
with drawer and plan to showcase.
cm. l. 120 p. 60 h. 47

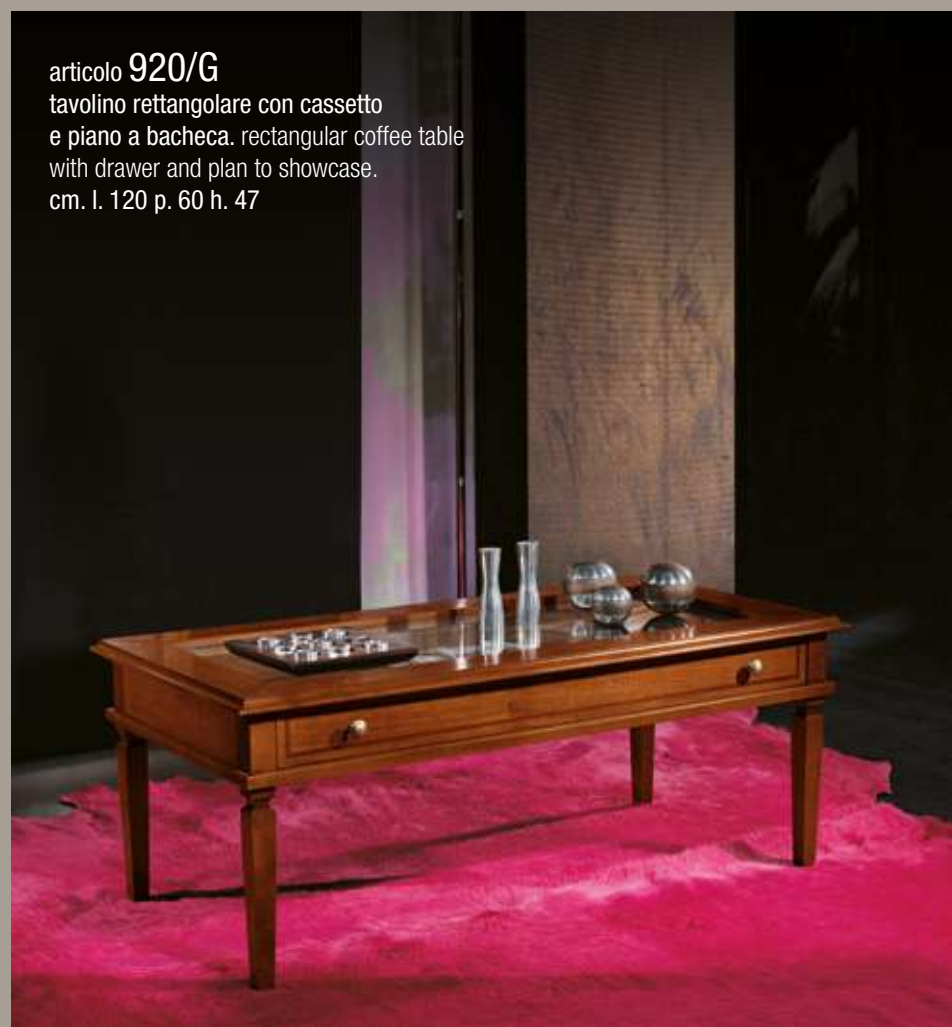

articolo 680/G
tavolino quadrato piano legno.
square coffee table wooden top.
cm. l. 110 p. 55 h. 45



articolo 662/G
tavolino rettangolare piano legno.
rectangular coffee table wooden top.
cm. l. 100 p. 50 h. 45

articolo 663/G
tavolino quadrato piano legno.
square coffee table wooden top.
cm. l. 60 p. 60 h. 45

articolo 664/G
tavolino quadrato piano legno.
square coffee table wooden top.
cm. l. 60 p. 60 h. 60



COLLECTION
BELVEDERE

articolo 1002/G
tavolino quadrato piano vetro.
square coffee table solid glass top.
cm. l. 60 p. 60 h. 47

articolo 1004/G
tavolino quadrato piano vetro.
square coffee table solid glass top.
cm. l. 70 p. 40 h. 47



articolo 114/G
portavasi quadrato, square pot holder.
cm. l. 34 p. 34 h. 116

articolo 114/GB
portavasi quadrato, square pot holder.
cm. l. 34 p. 34 h. 84



articolo 676/G
libreria 2 cassetti fianchi a crociera.
2 drawers bookcase with cross sides.
cm. l. 39 p. 30 h. 100

articolo 429/G
portavasi rotondo, round pot holder.
cm. ø. 31 h. 100

articolo 429/GB
portavasi rotondo, round pot holder.
cm. ø. 31 h. 75



articolo 683/G
portavasi quadrato, square pot holder.
cm. l. 36 p. 36 h. 107



COLLECTION BELVEDERE



articolo 681/G
consolle 1 cassetto, 1 drawer console.
cm. l. 36 p. 30 h. 81

COLLECTION BELVEDERE

FONDINI DISPONIBILI PER SEDIE
VEDI PAGINA SUCCESSIVA
SEATS AVAILABLE FOR CHAIRS
SEE NEXT PAGE



fondino paglia.
straw seat.



fondino legno.
wooden seat.



fondino ecrù.
ecrù seat.

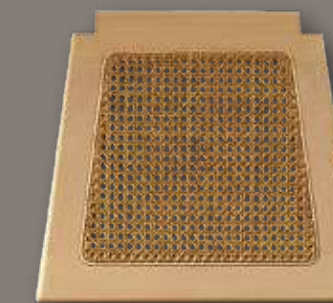

fondino paglia di Vienna.
Vienna straw seat.



telaio da imbottire.
frame to be upholstered.



articolo 310/G
 sedia con fondino paglia o legno.
 chair with straw or wooden seat.
 cm. l. 43 p. 42 h. 88 hs. 47



articolo 310/GS
 sgabello in faggio fondino imbottito.
 beech wood stool upholstered seat.
 cm. l. 41 p. 44 h. 101 h.s. 73



articolo 311/G
 sedia con fondino paglia o legno.
 chair with straw or wooden seat.
 cm. l. 43 p. 42 h. 88 hs. 47



articolo 313/G
 sgabello in faggio fondino paglia.
 beech wood stool straw seat.
 cm. l. 41 p. 44 h. 73



articolo 378/G
 sedia con fondino standard.
 chair with standard seat.
 cm. l. 46 p. 45 h. 91,5 hs. 45,5



articolo 379/G
 sedia con fondino standard.
 chair with standard seat.
 cm. l. 46 p. 45 h. 91,5 hs. 45,5



articolo 380/G
 sedia con fondino paglia o legno.
 chair with straw or wooden seat.
 cm. l. 47 p. 42 h. 87 hs. 48,5



articolo 380/SG
 sgabello con fondino paglia o legno.
 Stool with straw or wooden seat.
 cm. l. 44 p. 41 h. 96 h.s. 68



articolo 325/G
 sedia con fondino standard.
 chair with standard seat.
 cm. l. 43,5 p. 43 h. 90,5 hs. 45,5



articolo 325/SG
 sgabello con fondino paglia o legno.
 Stool with straw or wooden seat.
 cm. l. 43 p. 46 h. 115 h.s. 73



articolo 326G
 sedia in faggio fondino legno.
 beech wood chair wooden seat.
 cm. l. 43 p. 46 h. 81,5 h.s. 46,5



articolo 326/GS
 sgabello in faggio fondino legno.
 beech wood stool wooden seat.
 cm. l. 39 p. 45 h. 110 h.s. 79



articolo 381/G
 sedia con fondino paglia o legno.
 chair with straw or wooden seat.
 cm. l. 46 p. 47 h. 94,5 hs. 45,5



articolo 405/G
 sedia con fondino standard.
 chair with standard seat.
 cm. l. 43 p. 44 h. 93 hs. 45,5



articolo 408/G
 sedia con fondino standard.
 chair with standard seat.
 cm. l. 44 p. 43 h. 93,5 hs. 45,5



articolo 425/G
 sedia con fondino standard.
 chair with standard seat.
 cm. l. 44 p. 42,5 h. 93,5 hs. 45,5



articolo 327G
 sedia in faggio fondino legno.
 beech wood chair wooden seat.
 cm. l. 43 p. 46 h. 81,5 h.s. 46,5



articolo 327/GS
 sgabello in faggio fondino legno.
 beech wood stool wooden seat.
 cm. l. 39 p. 45 h. 110 h.s. 79



articolo 375/G
 sedia con fondino standard.
 chair with standard seat.
 cm. l. 46 p. 45 h. 91,5 hs. 45,5



articolo 377/G
 sedia con fondino standard.
 chair with standard seat.
 cm. l. 46 p. 45 h. 91,5 hs. 45,5



articolo 488/G
 sgabello con fondino paglia o legno.
 Stool with straw or wooden seat.
 cm. l. 38 p. 38 h. 73



articolo 489/G
 sgabello con fondino paglia o legno.
 Stool with straw or wooden seat.
 cm. l. 38 p. 38 h. 45,5



articolo 622/G
 sedia con fondino imbottito.
 chair with upholstered seat.
 cm. l. 46 p. 41,5 h. 95,5 h.s. 45,5



articolo 750/G
 fusto da imbottire.
 chair frame for upholstered.
 cm. l. 50 p. 50 h. 104 h.s. 43

ZONA GIORNO LIVING ROOM



NATURAL CHIC E.CHIC4 pag.94 NATURAL CHIC pag.102.103



NATURAL CHIC pag.95 DIAMANTE 15 pag.148



DIAMANTE 23 pag.149 DIAMANTE 26 pag.154.155

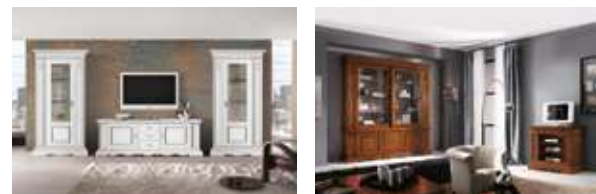

BAGNO BATHROOMS



CASSETTIERE DRESSER



CONTRACT CONTRACT



CONSOLE CONSOLE



CRENZE SIDEBOARDS



CRENZINE SMALL SIDEBOARDS



CAMERE BEDROOMS



NATURAL CHIC pag.117 NATURAL CHIC pag.118.119



NATURAL CHIC EC-031 pag.132.133 NATURAL CHIC pag.130.131



NATURAL CHIC pag.136.137 NATURAL CHIC pag.126.127



ARMADI WARDROBES



EC-029 pag.134.135 EC-030 pag.124.139 EC-030V pag.125.126



EC-031 pag.132 EC-031 pag.118.122



ENTRATE ENTRANCE



PORTA TV TV STAND



SEDIE CHAIRS



SCRIVANIE WRITING-DESK



ZONA STUDIO STUDY ROOM

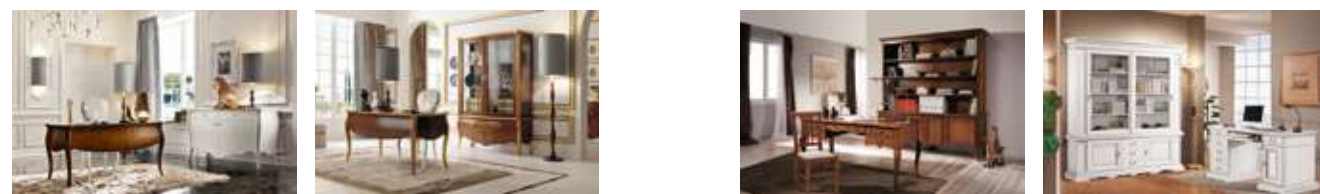

TAVOLINI COFFEE TABLES



TAVOLI TABLES



UTILITY UTILITY



VETRINE SHOWCASE



VETRINETTE SMALL SHOWCASE



COLLECTIONS

HOMEVENTUNO

QUALITÀ E DESIGN DELL'ARREDAMENTO ITALIANO
QUALITY AND DESIGN OF ITALIAN FURNITURE

Questo catalogo è di proprietà della ditta e viene dato in uso esclusivamente ai rivenditori autorizzati.
Qualsiasi uso da parte di persone non autorizzate è perseguibile secondo i Termini previsti dalla legge.
È vietata la riproduzione e l'alterazione, anche in forma digitale, delle fotografie e dei marchi riprodotti nel catalogo.
Le eventuali differenze nei colori stampati non possono essere considerate difetti.
Le misure riportate sul catalogo sono da valutarsi come indicative.

The copyright of this catalogue belongs exclusively to company. It is for the exclusive Use of registered customers only. All contents are copyrighted. The contents may not be Reproduced in whole or in part without written consent of copyright owner.
We cannot accept any complaint on difference from the colours printed in this Catalogue. The measures listed in the catalogue are assessed as indicative.

 MADE IN ITALY